

Modellname:
Nazwa modelu:

ALASKA

Modellreihe:
Numer modelu:

P9 -- AS

Type:
Typ: **01**

Blatt Nr
Strona **1** von: **7**
z:

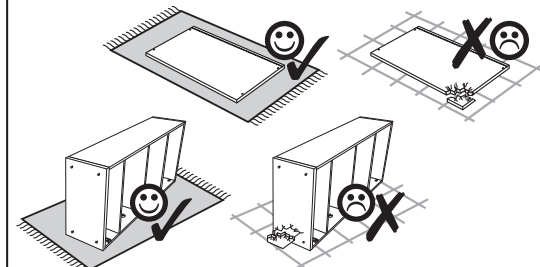
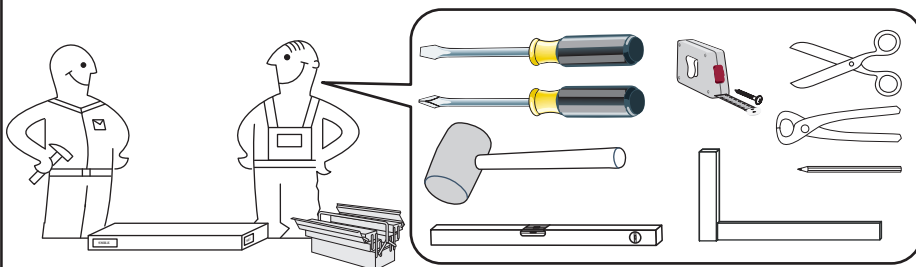
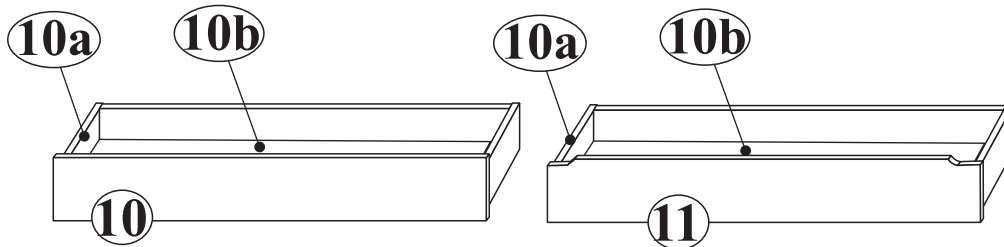
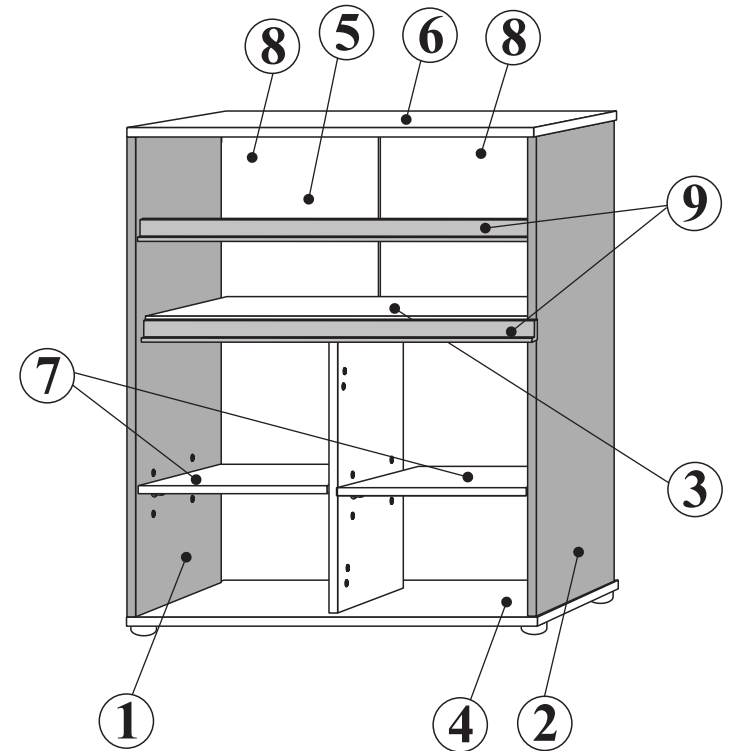
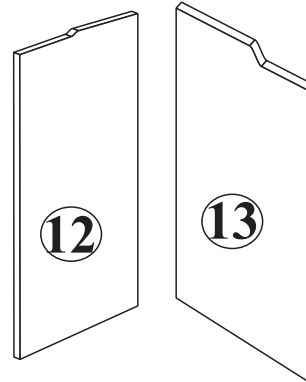
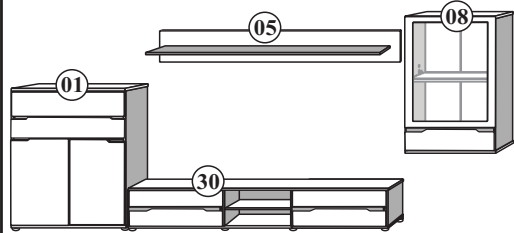
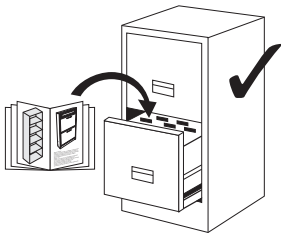
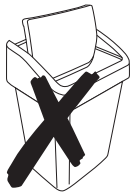

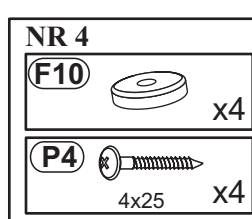
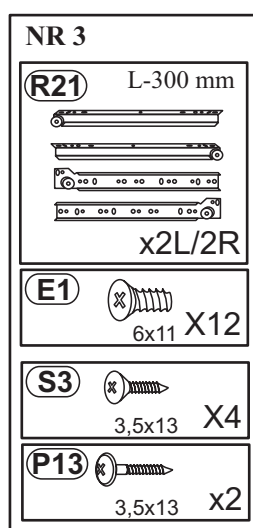
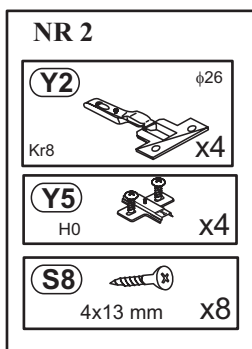
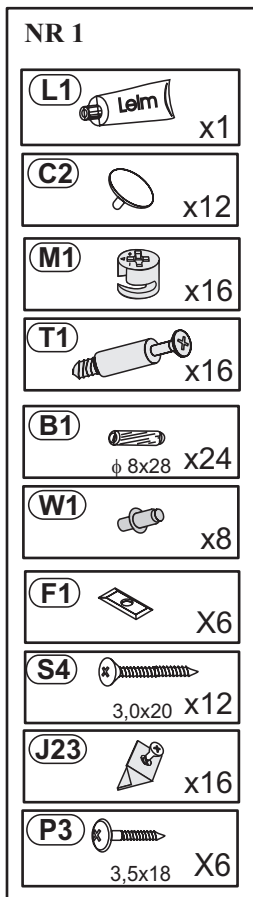

1

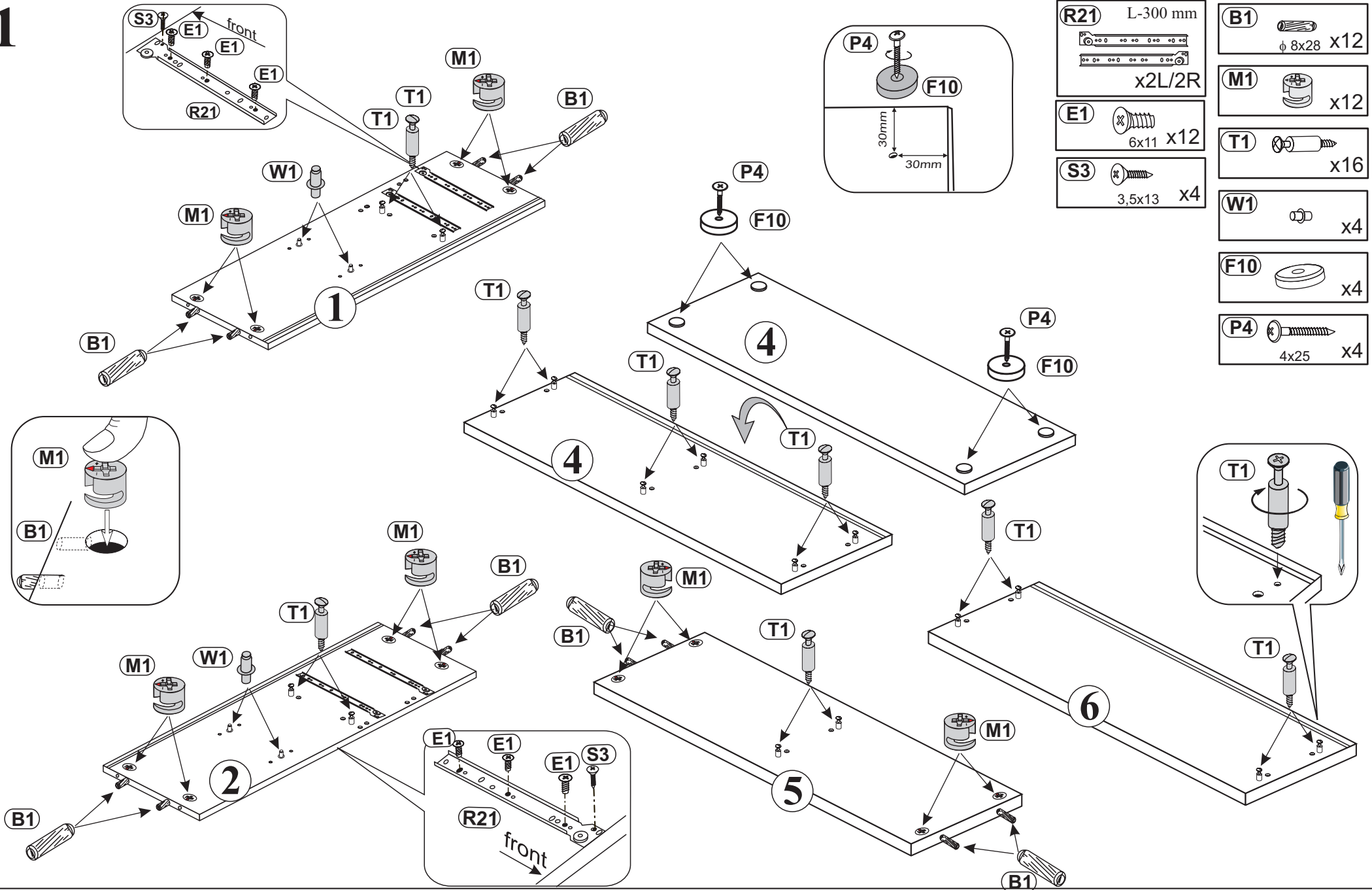



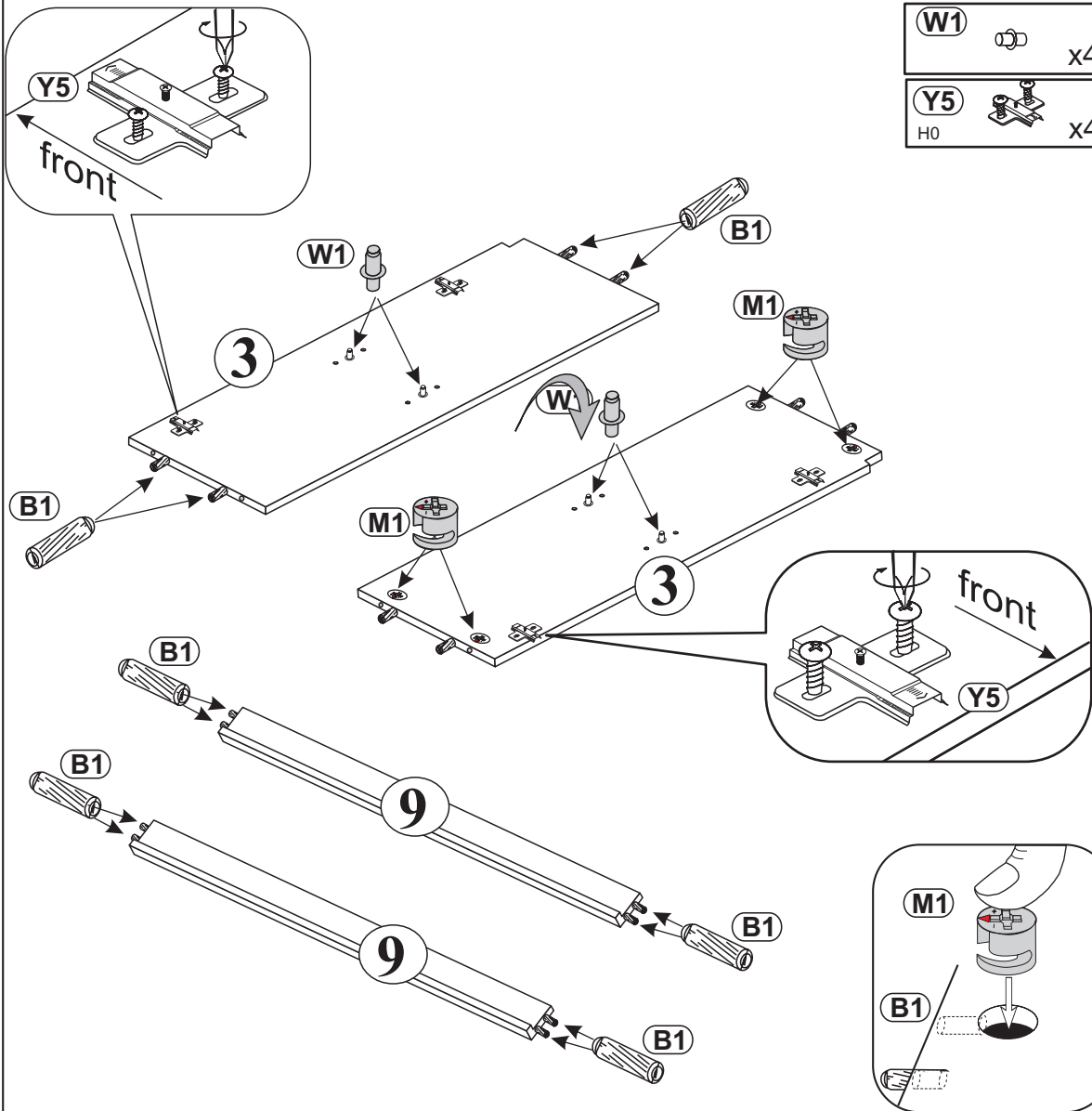

- (R21)** L-300 mm
x2L/2R
- (E1)** 6x11 x12
- (S3)** 3,5x13 x4

- (B1)** ϕ 8x28 x12
- (M1)** x12
- (T1)** x16
- (W1)** x4
- (F10)** x4
- (P4)** 4x25 x4



2

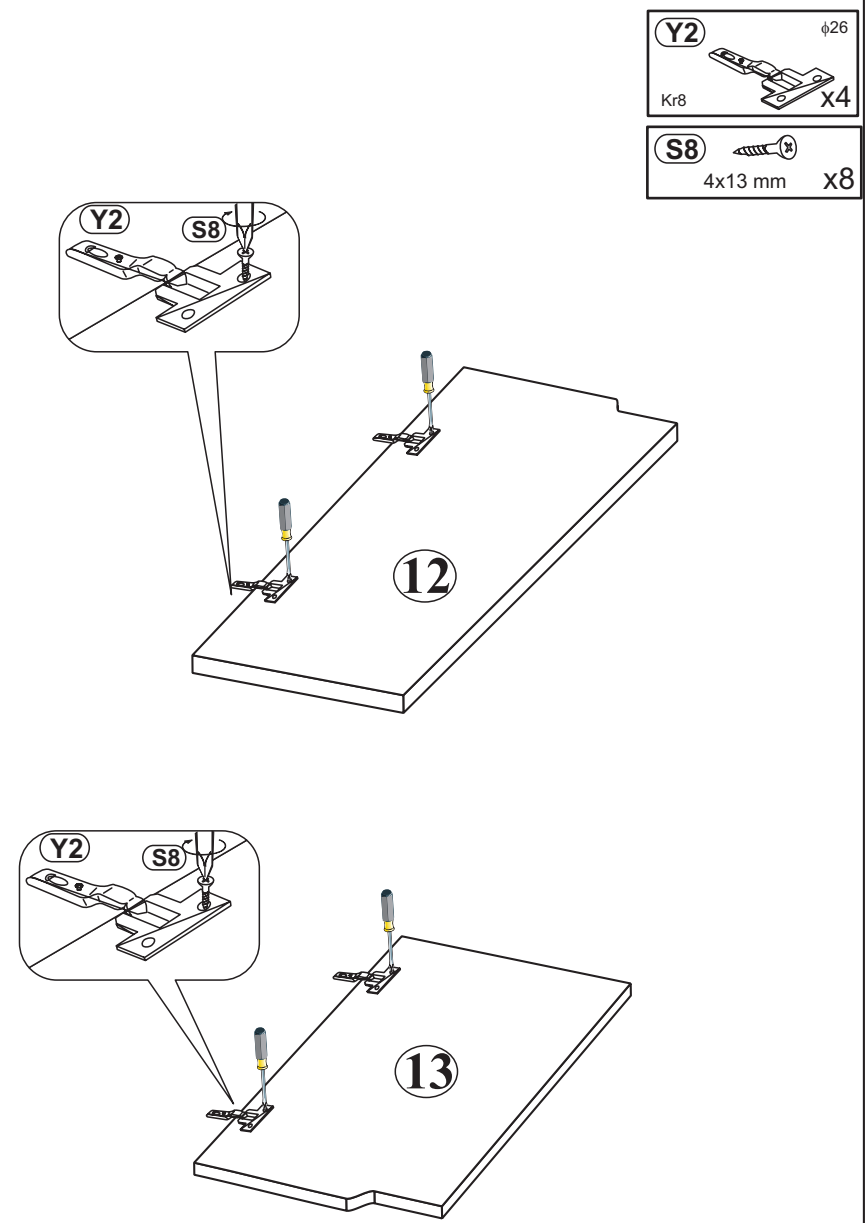

- B1**  $\phi 8 \times 28$ x16
- M1**  x4
- W1**  x4
- Y5**  H0 x4

3



- Y2**  $\phi 26$
Kr8 x4
- S8**  4x13 mm x8

4

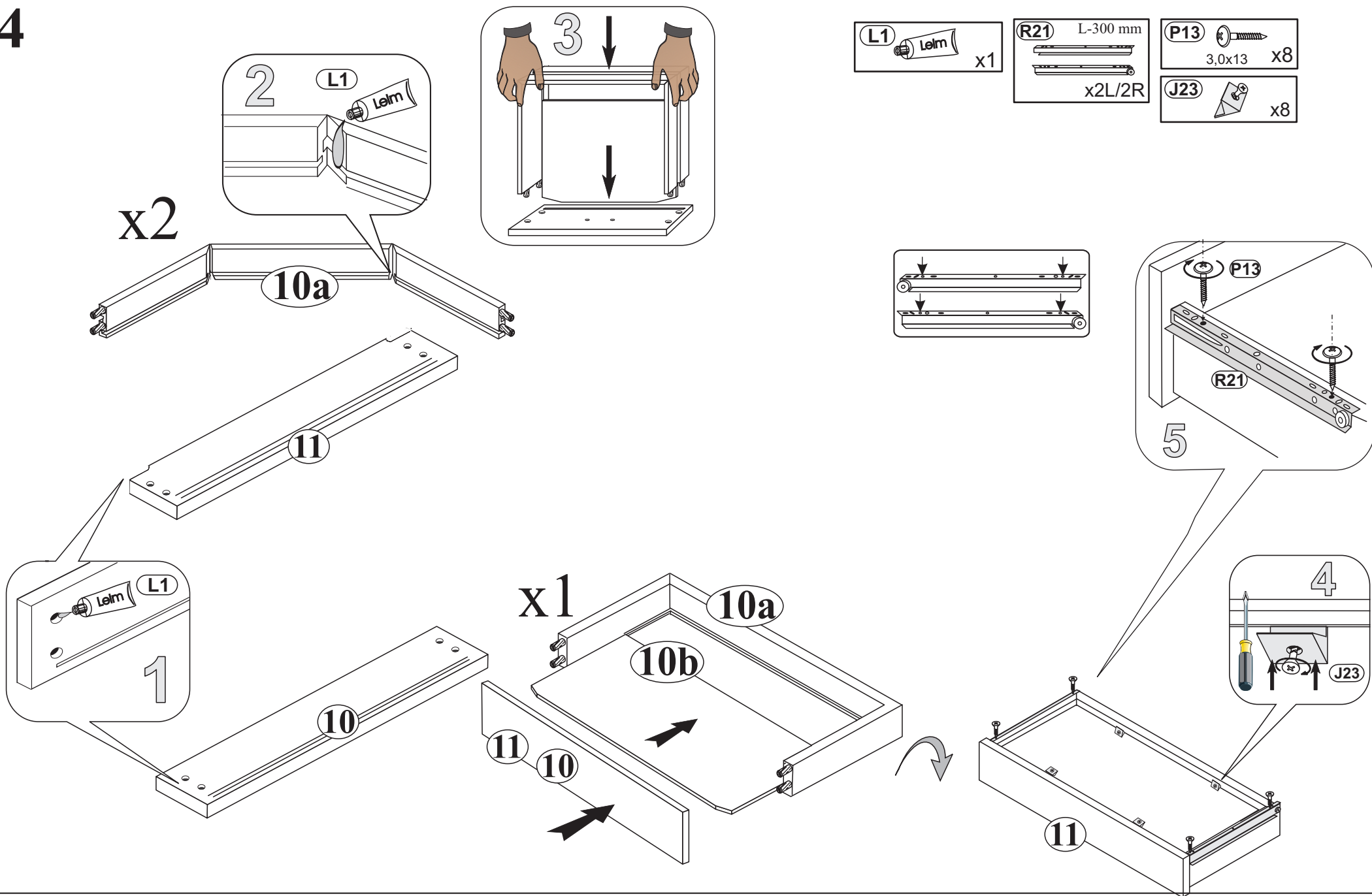

5

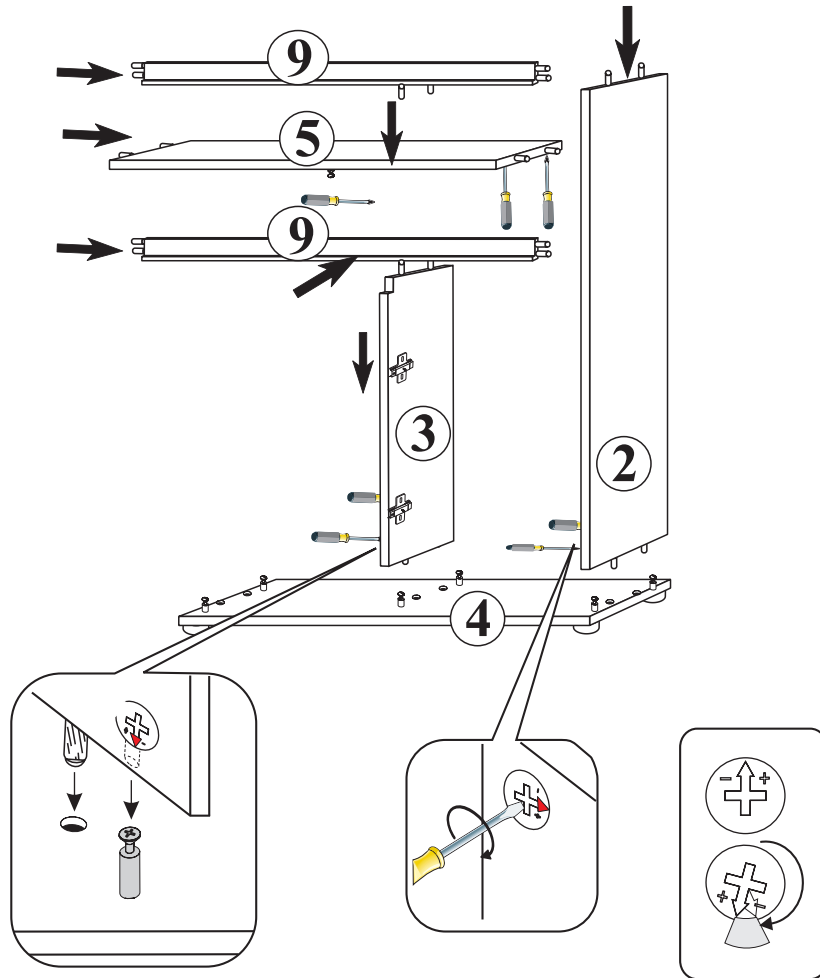

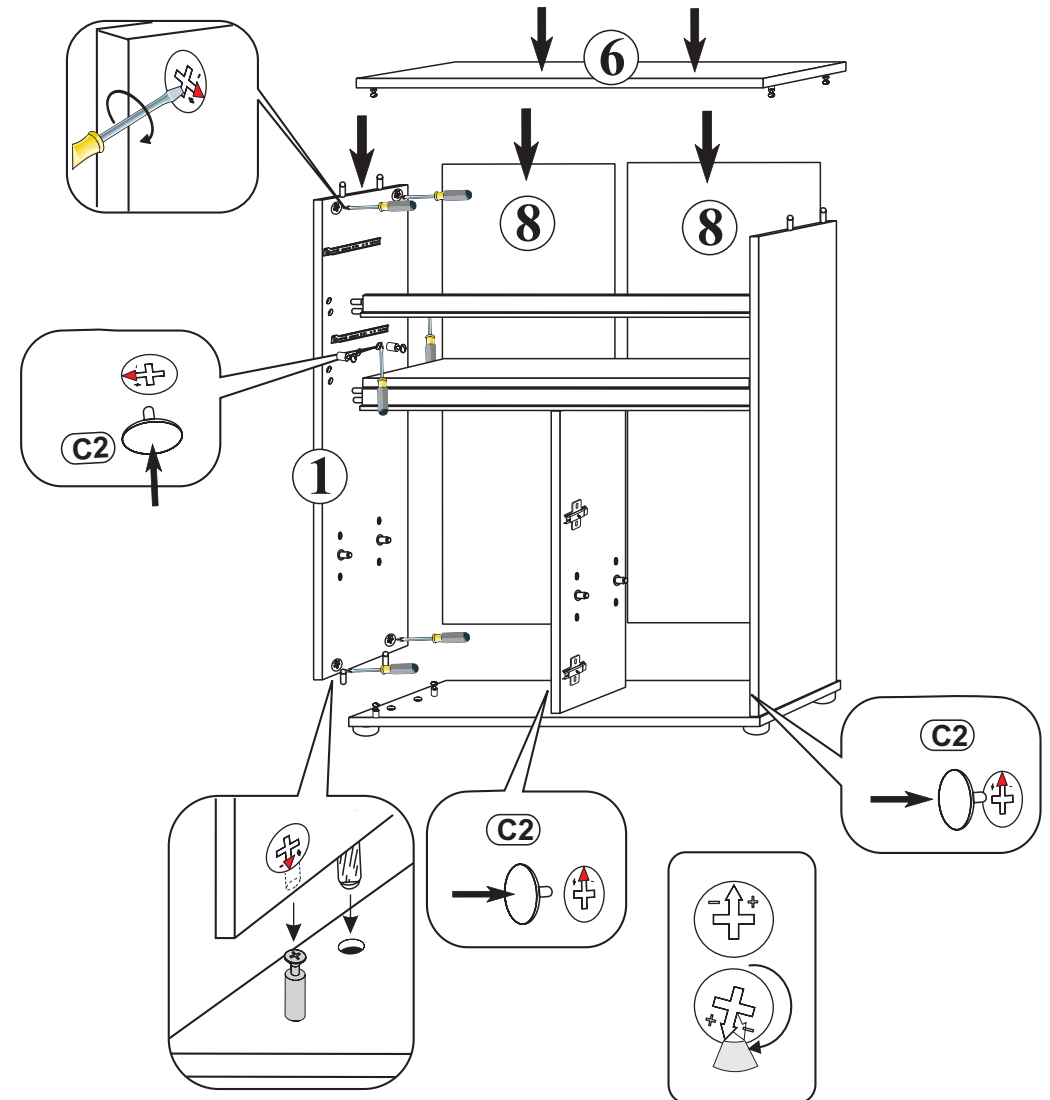

6

C2 X12



7

- F1**  X6
- S4**  3,0x20 X12
- J23**  X6

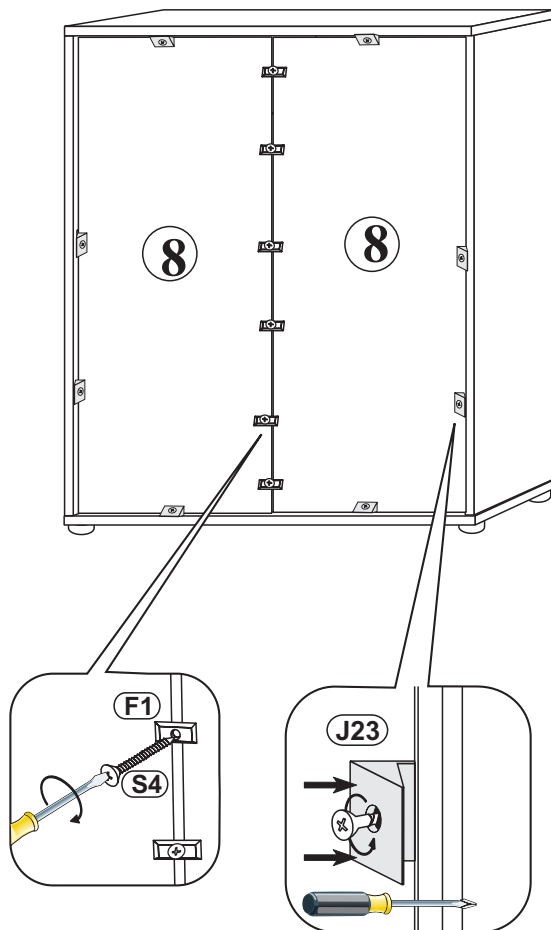

8

