

Modellname:
Nazwa modelu:

ALASKA

Modellreihe:
Numer modelu:

P9 -- AS

Type:
Typ: **30**

Blatt Nr 1 von: 6
Strona z:

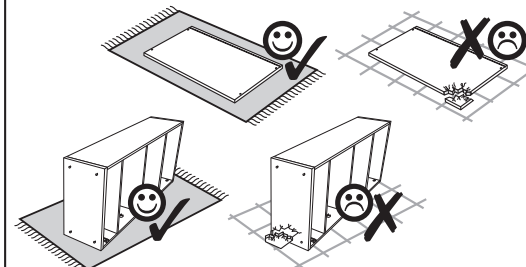
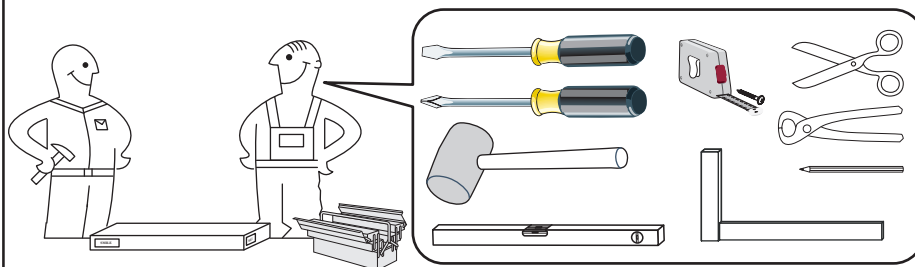
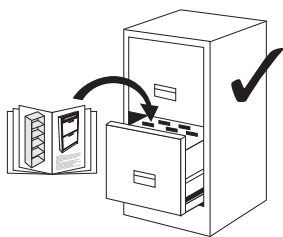
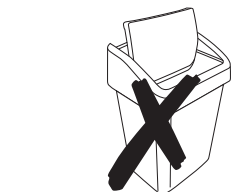
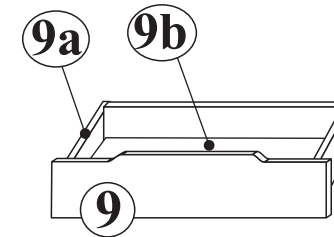
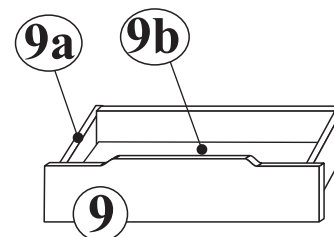
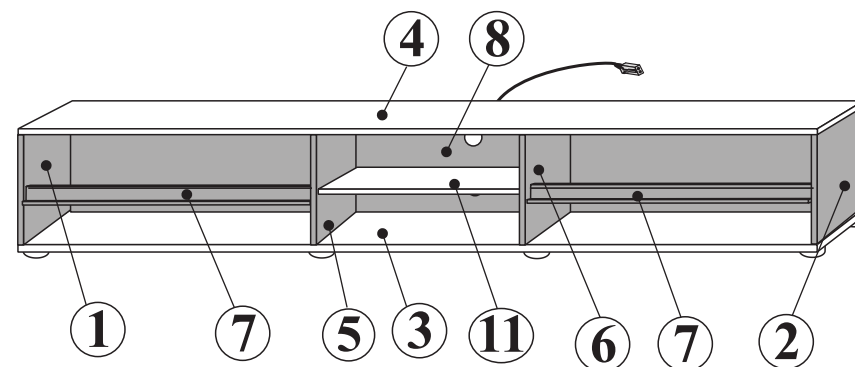
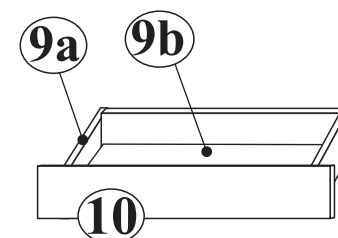
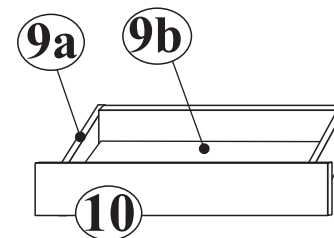
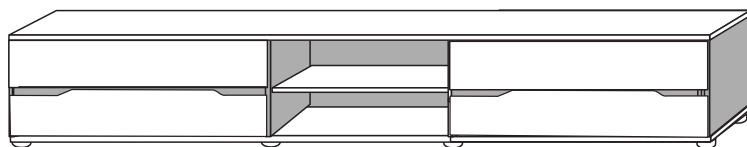
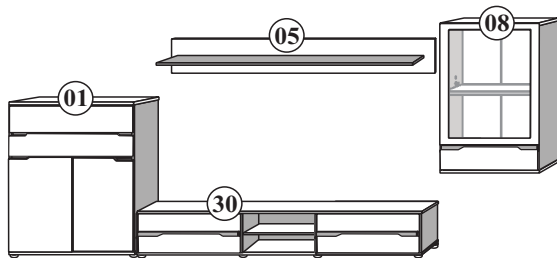

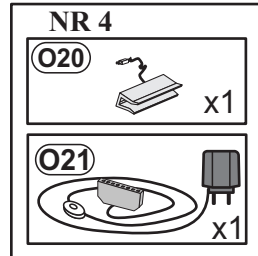
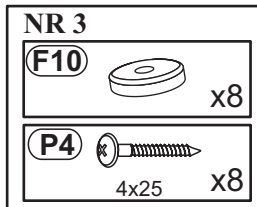
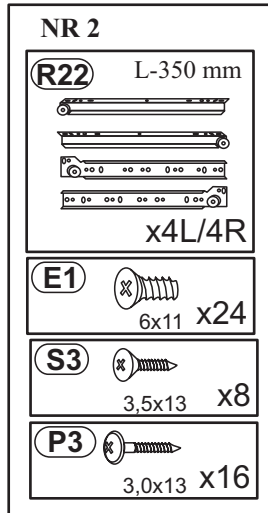
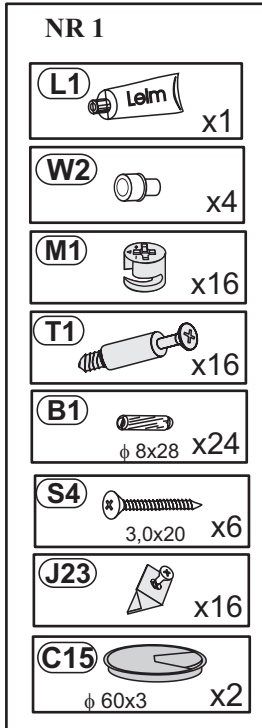

1

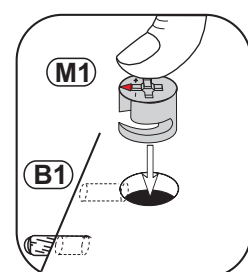
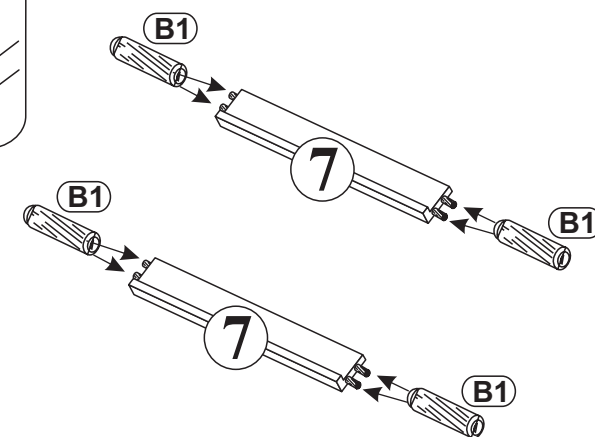
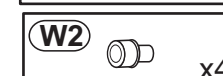
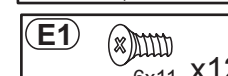
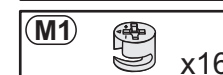
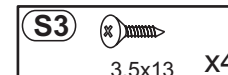
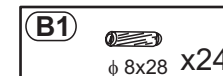
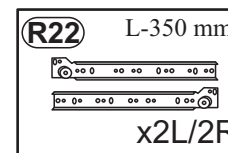
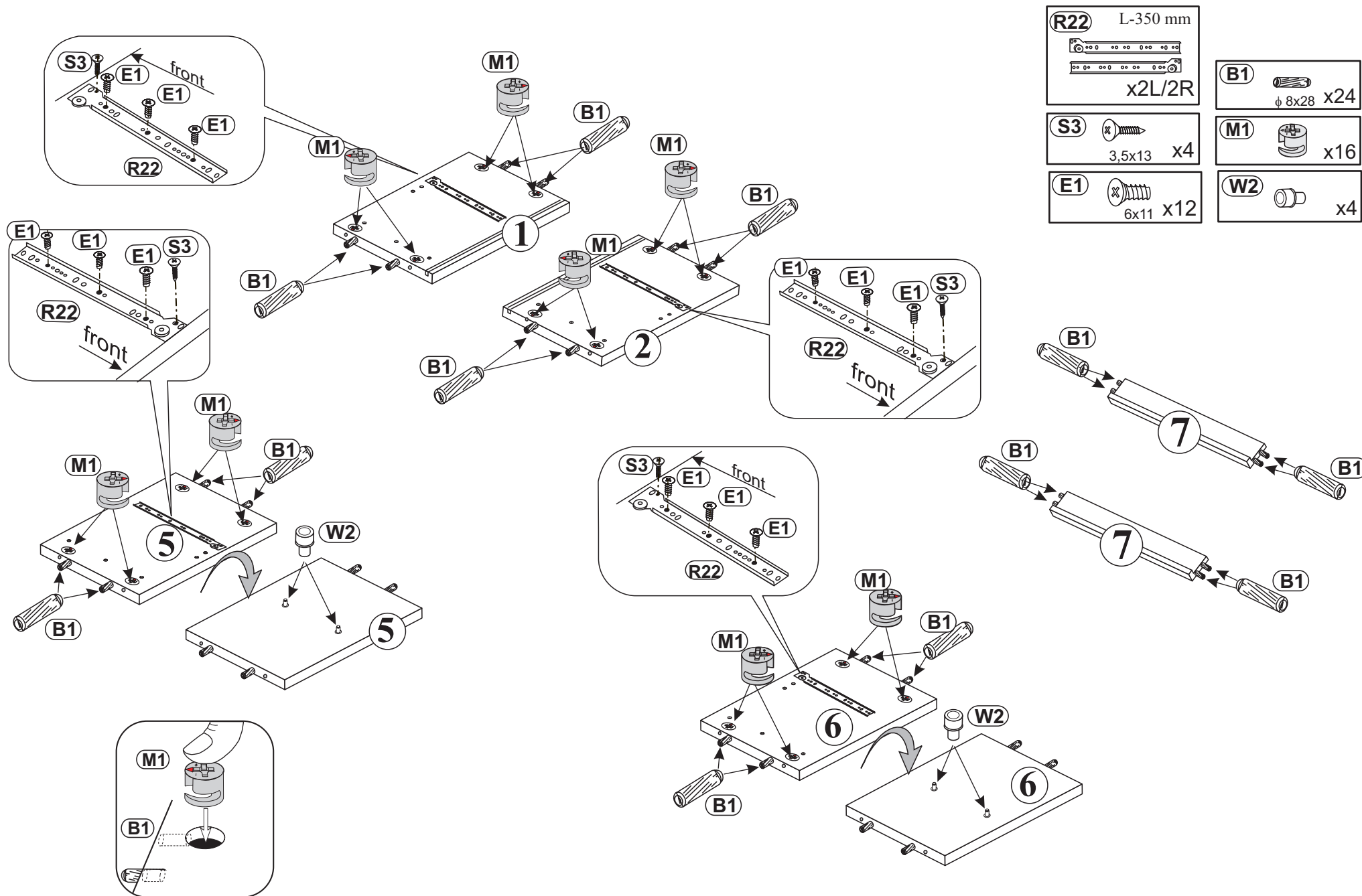

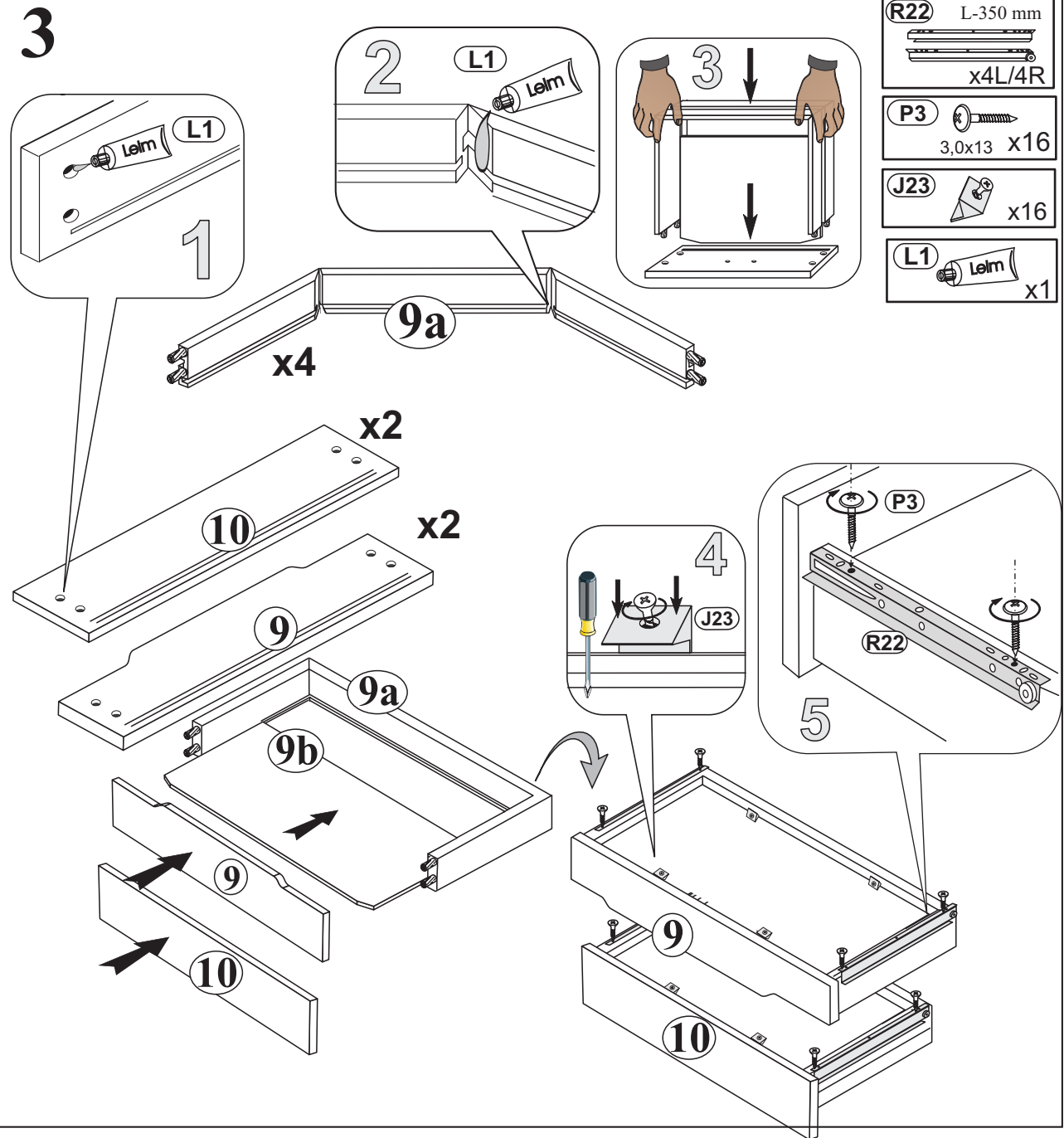
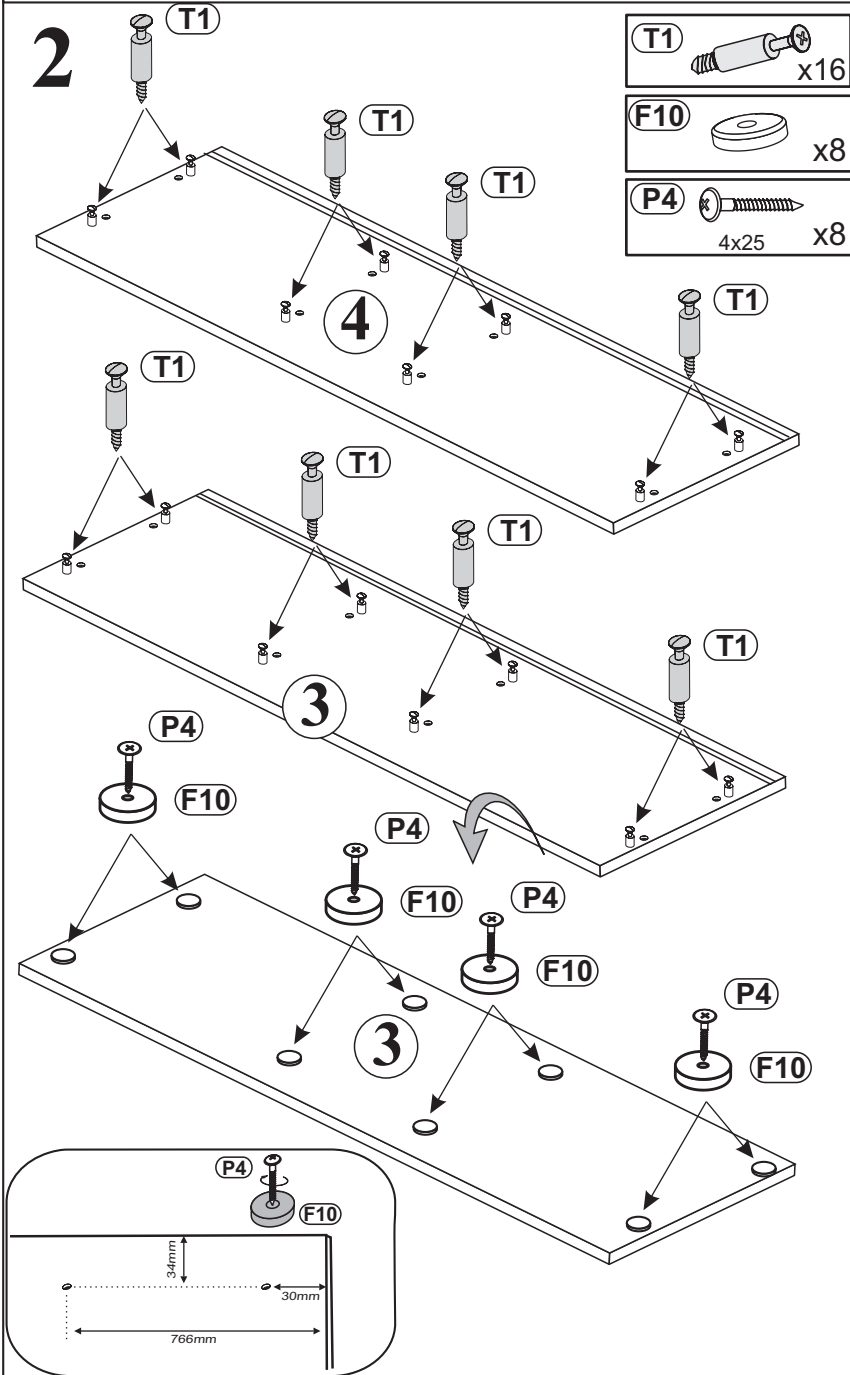

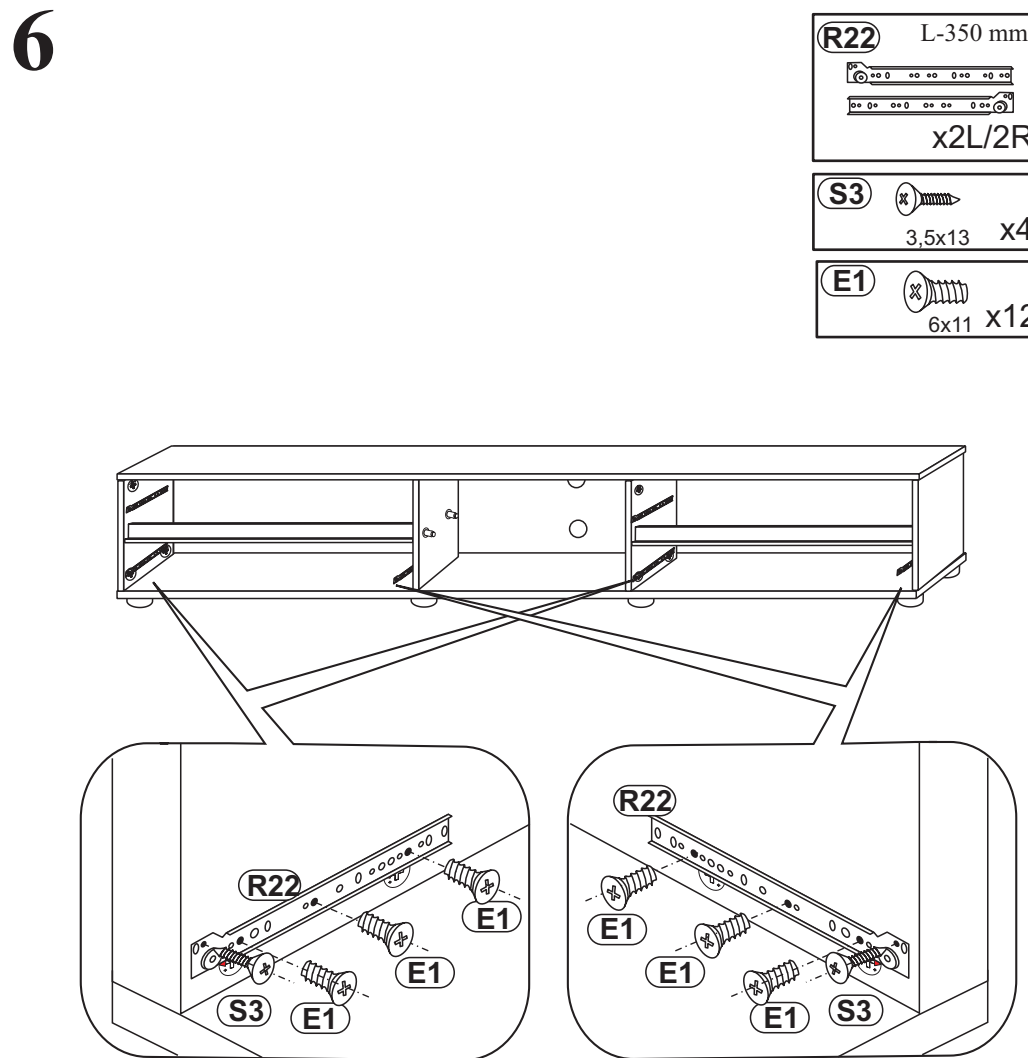
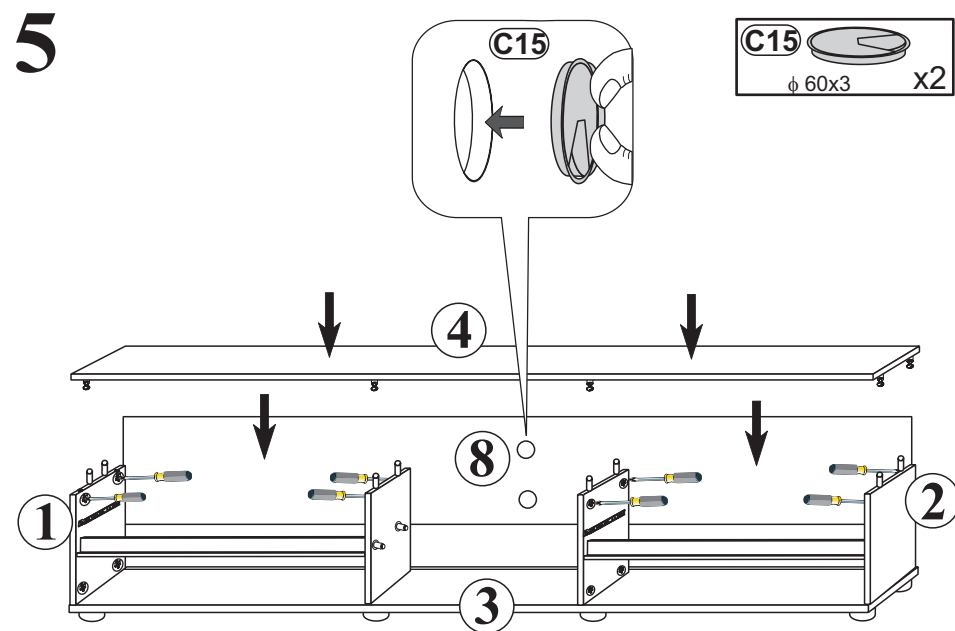
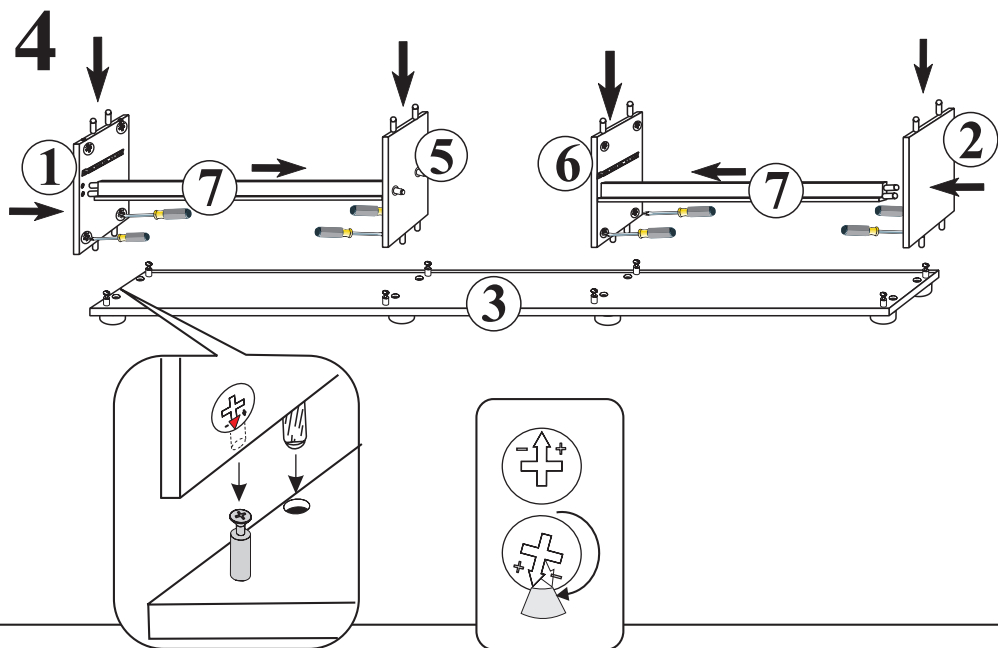

7

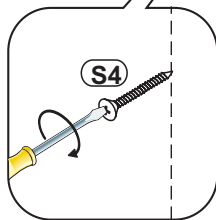
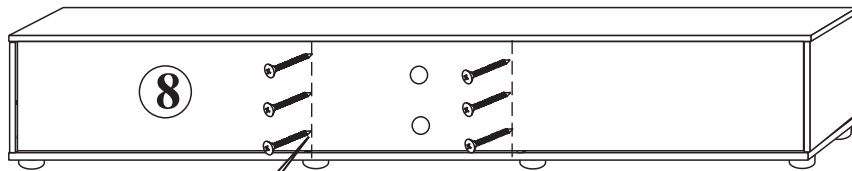
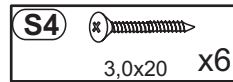

8

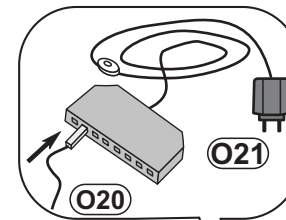
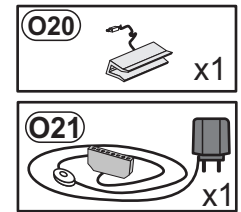

O20

Anschluß für
Zubehörtype - Trafo

