

2 Personen
2 Osoby

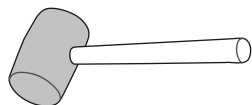

NR 3

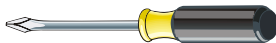
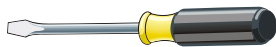
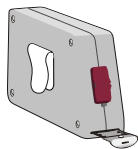
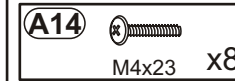

NR 3

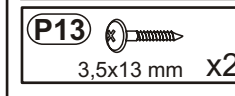
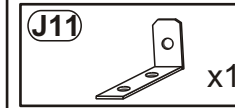

NR 1

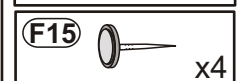
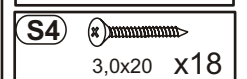
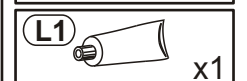
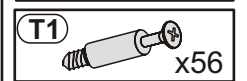
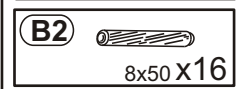
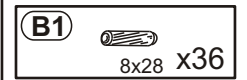

NR 2

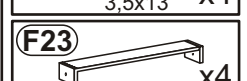
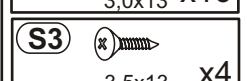
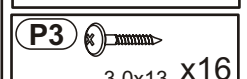
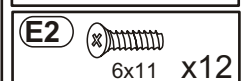
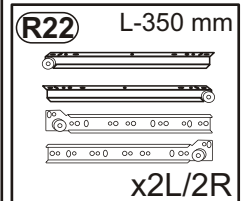

1

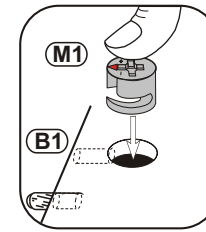
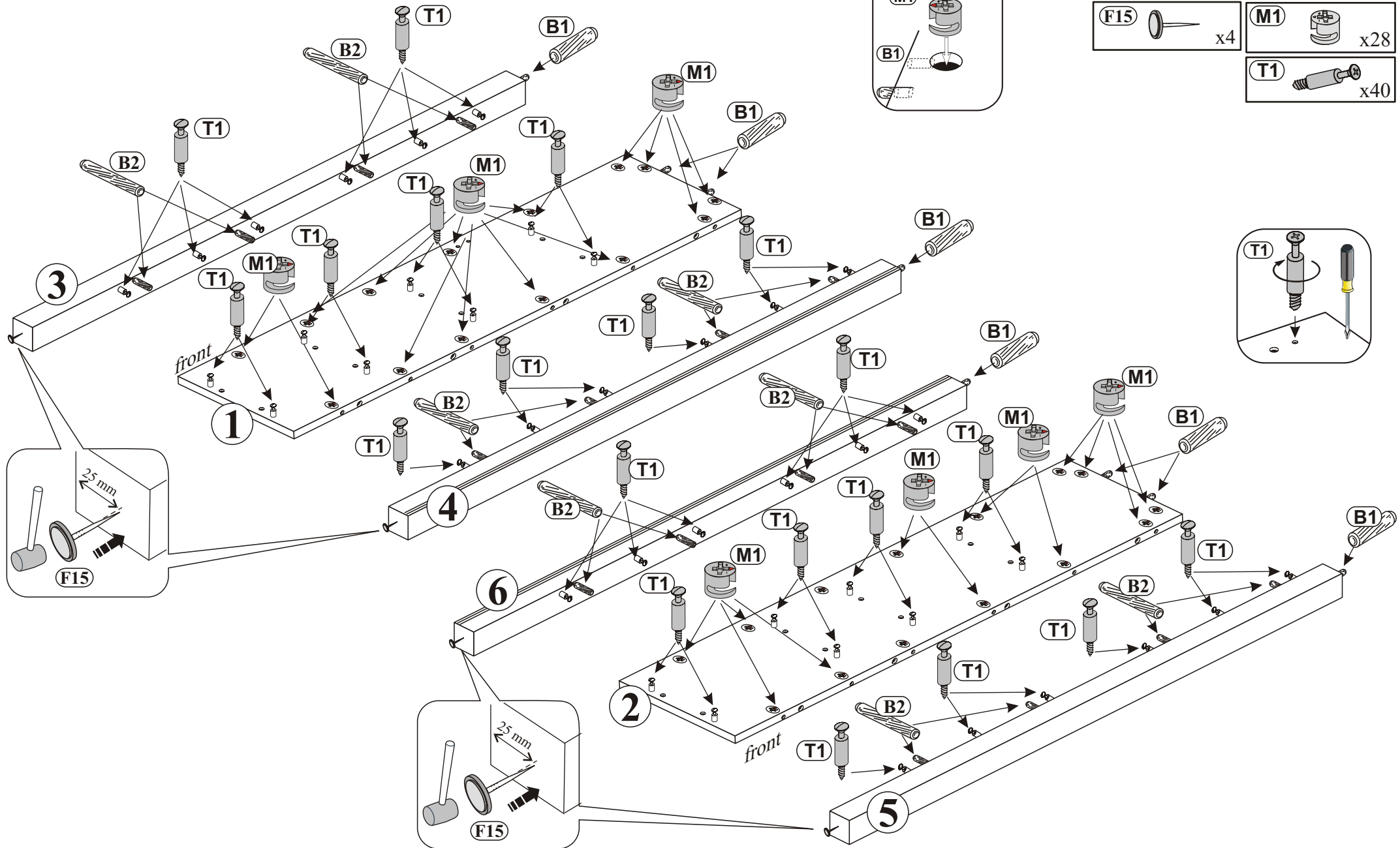

B2		f 8x50	x16
F15			x4

B1		f 8x28	x8
M1			x28

T1			x40
-----------	--	--	-----

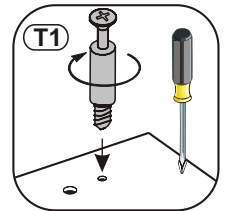

2

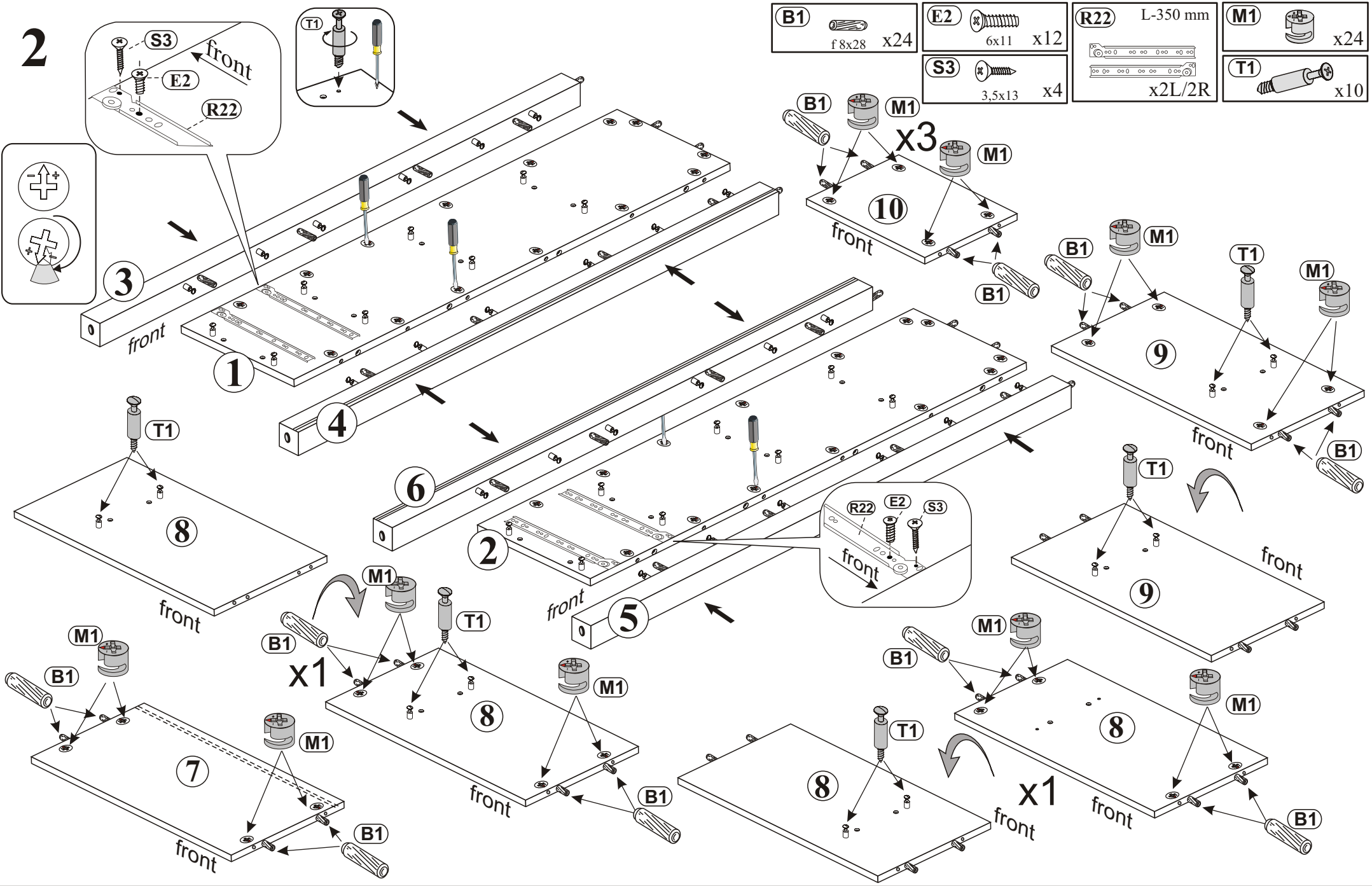

B1 f 8x28 x24

E2 6x11 x12

R22 L-350 mm
 x2L/2R

M1 x24

S3 3,5x13 x4

T1 x10

B1 **M1** **X3** **M1**

B1 **M1** **T1** **M1**

R22 **E2** **S3**

M1 **B1** **X1** **T1** **M1**

B1 **M1** **X1** **M1** **T1**

3

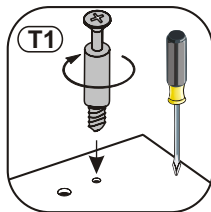
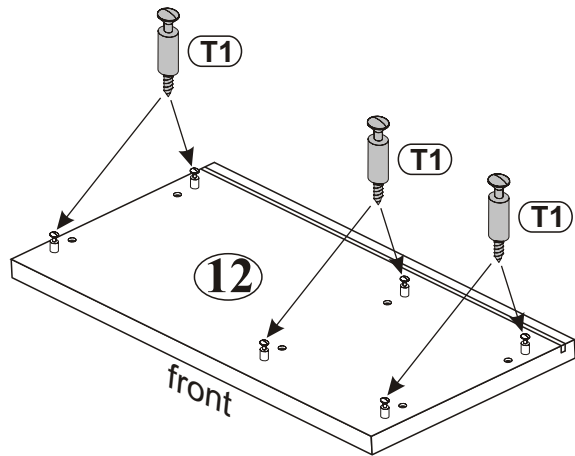
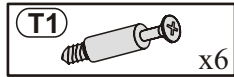

4

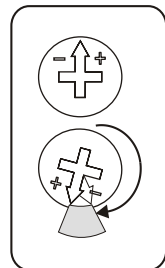
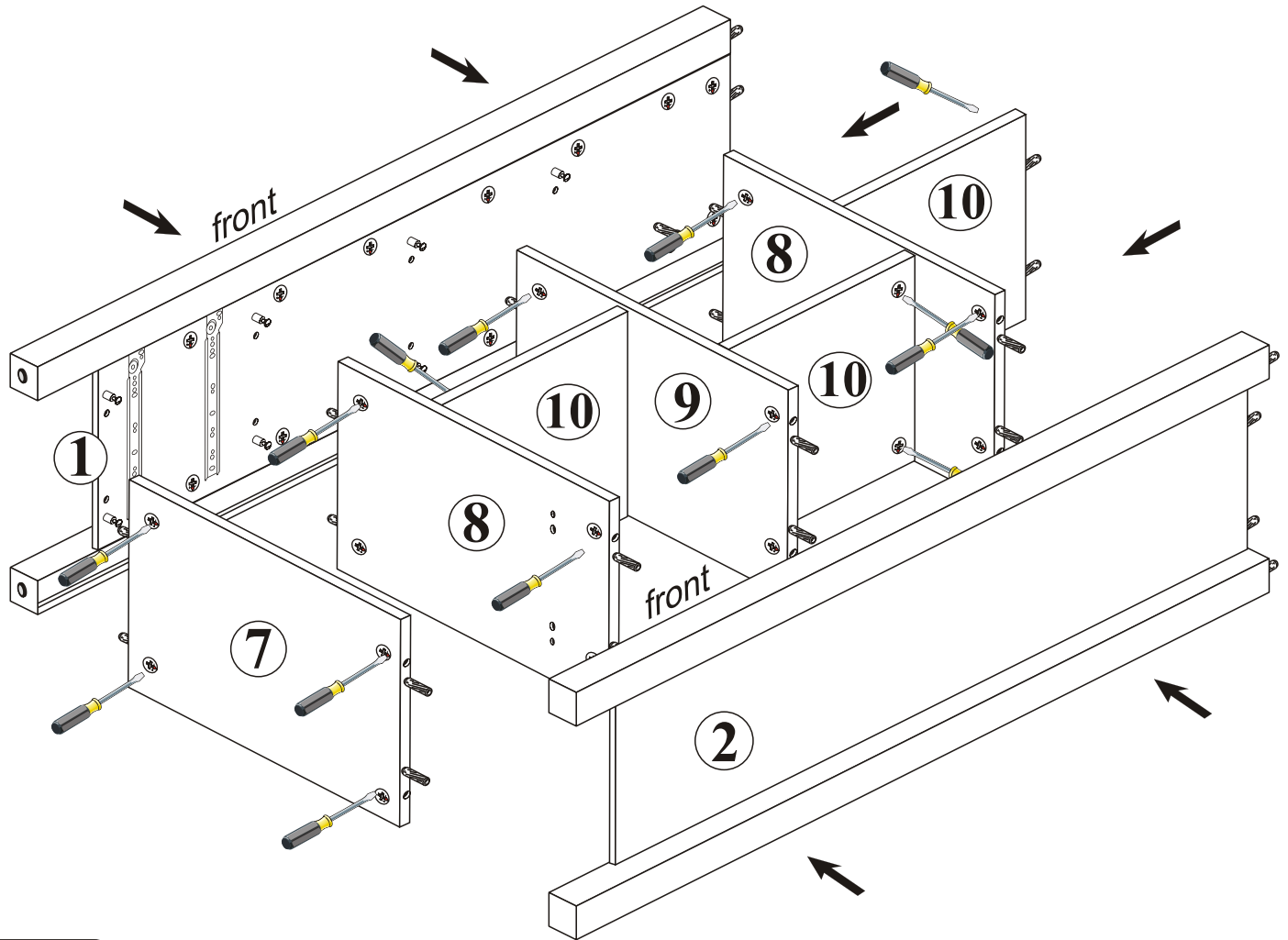



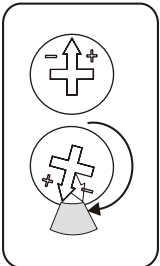
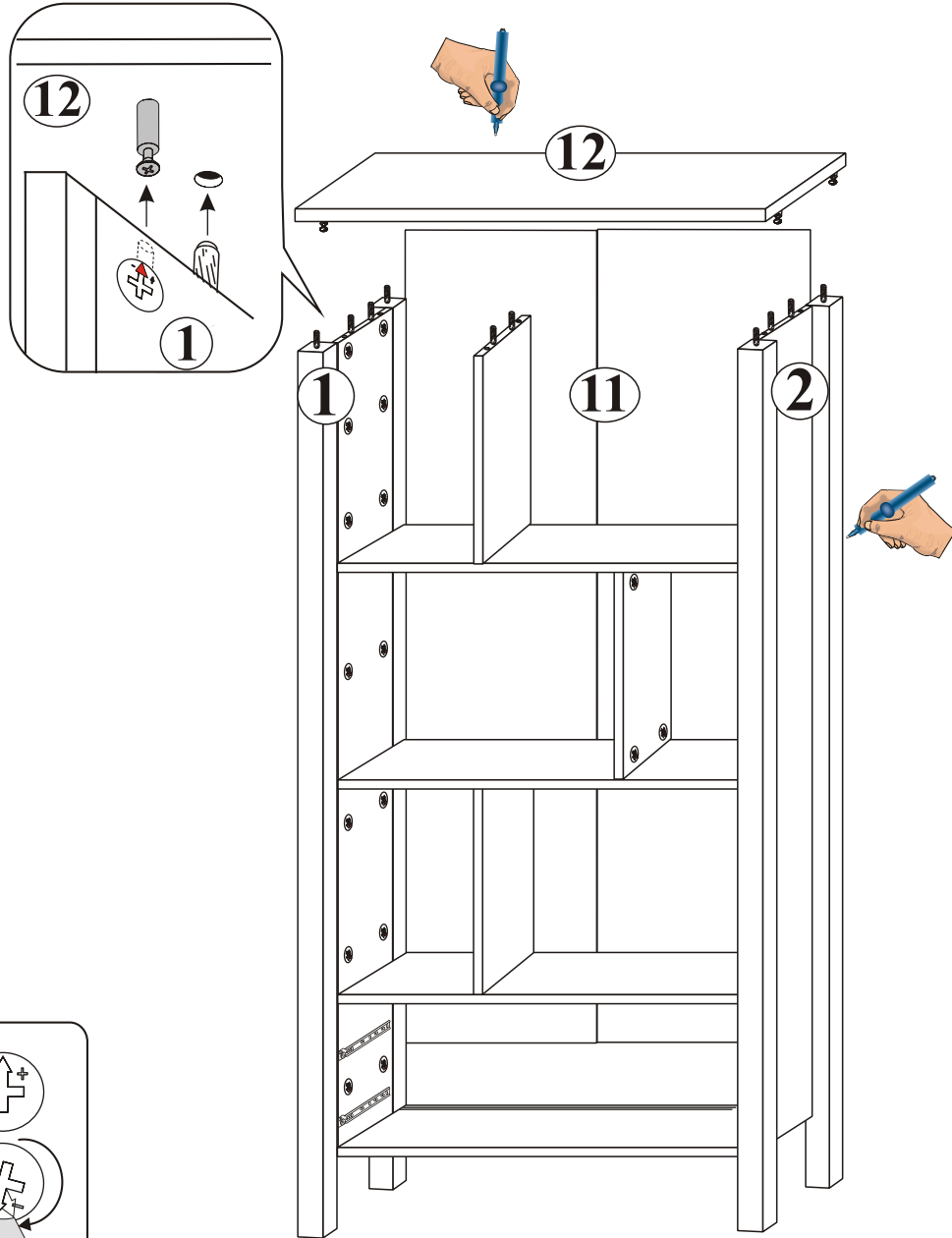

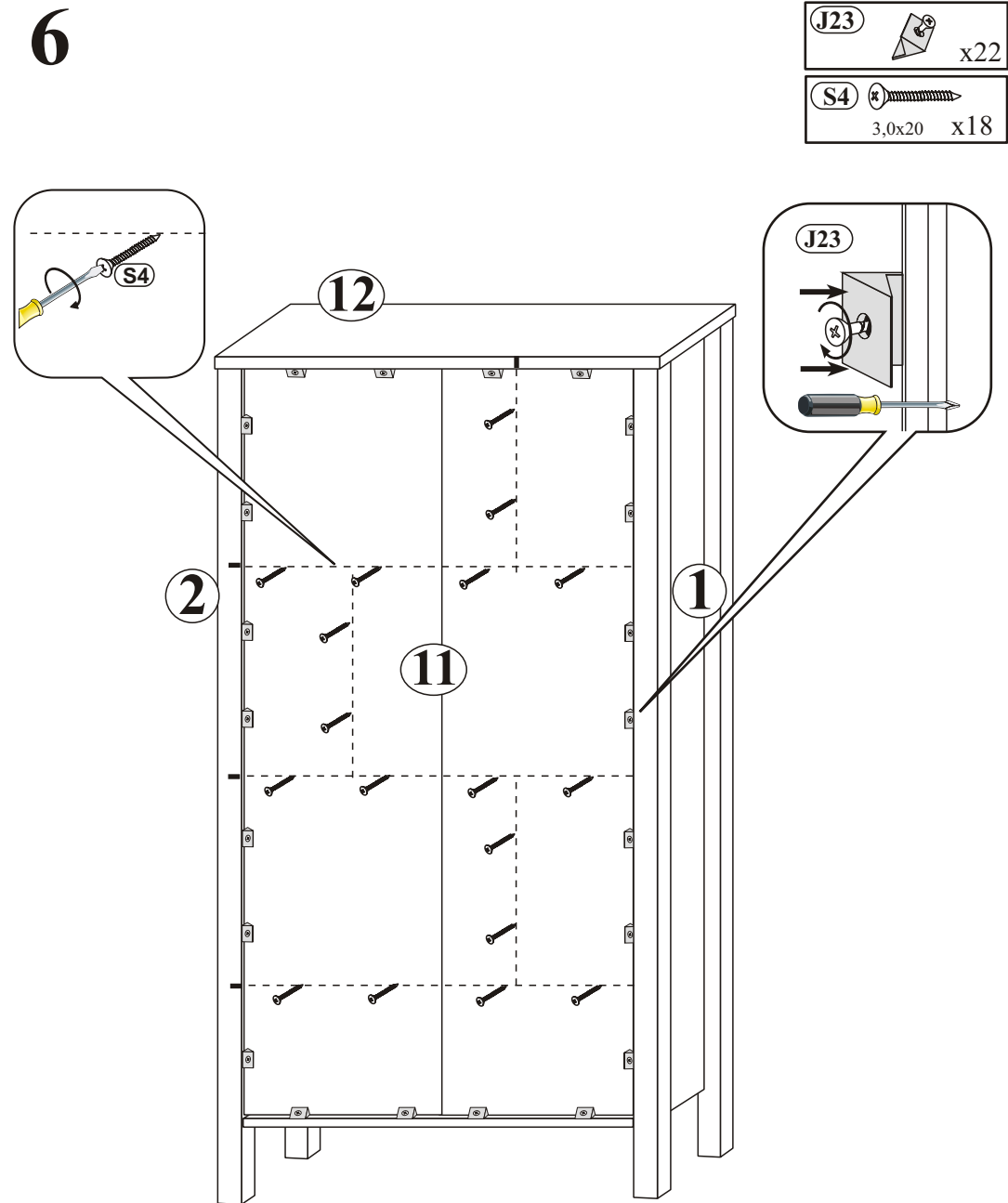

5



6

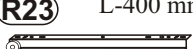

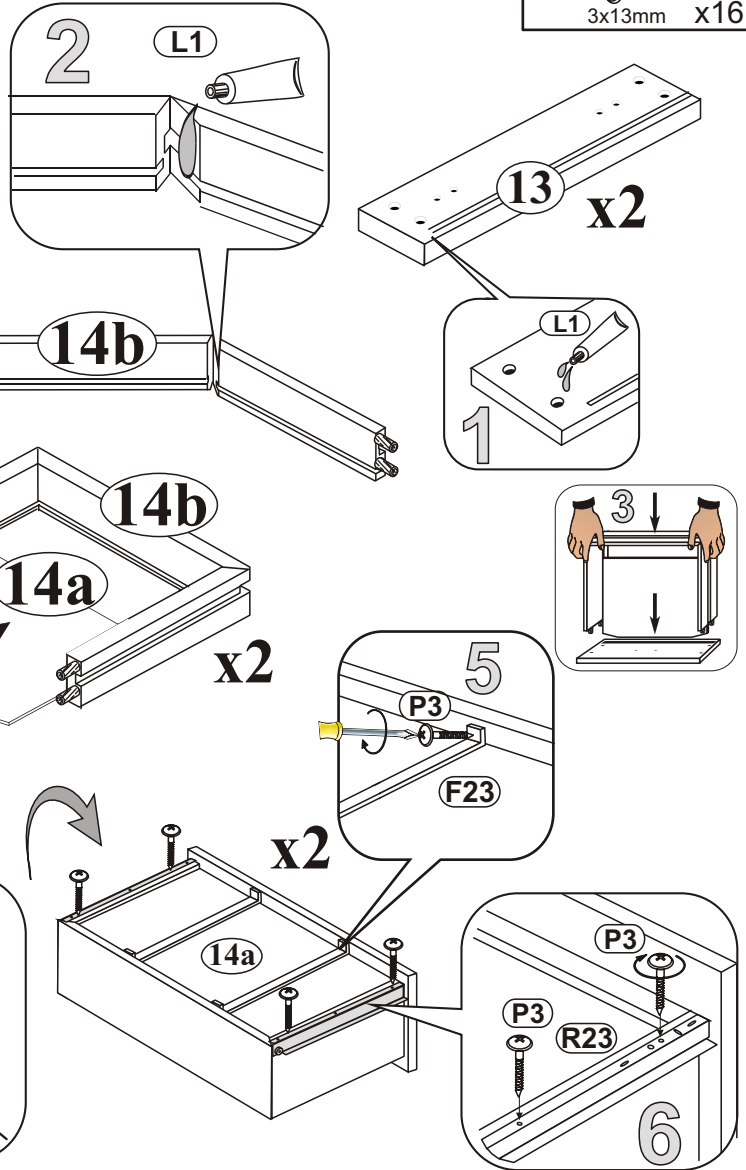

7

- U61**  x4
- F23**  x4
- R23** L-400 mm  x2L/2R
- A14**  M4x23 x8
- L1**  x1
- P3**  3x13mm x16



8

- J11**  x1
- P13**  3,5x13 mm x2
- C2**  x44

