

2 Personen
2 Osoby

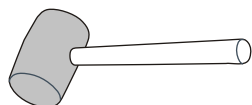
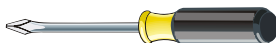
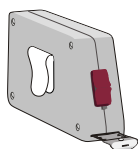

NR 2	
Y1 Kr15	26 x4
Y5 H2	x4
S8 4x13 mm	x8
E3 6,3x13	x8

NR 3	
U61	x2
A14 M4x23	x4

NR 4	
J44	x1
P13 3,5x13	1x
G22	x2

NR 1	
B1 8x28	x16
B2 8x50	x8
L1 Leim	x1
M1	x24
T1	x24
W1	x8
F1	x4
S4 3,0x20	x4
J23	x14
C2	x28
F15	x4



1

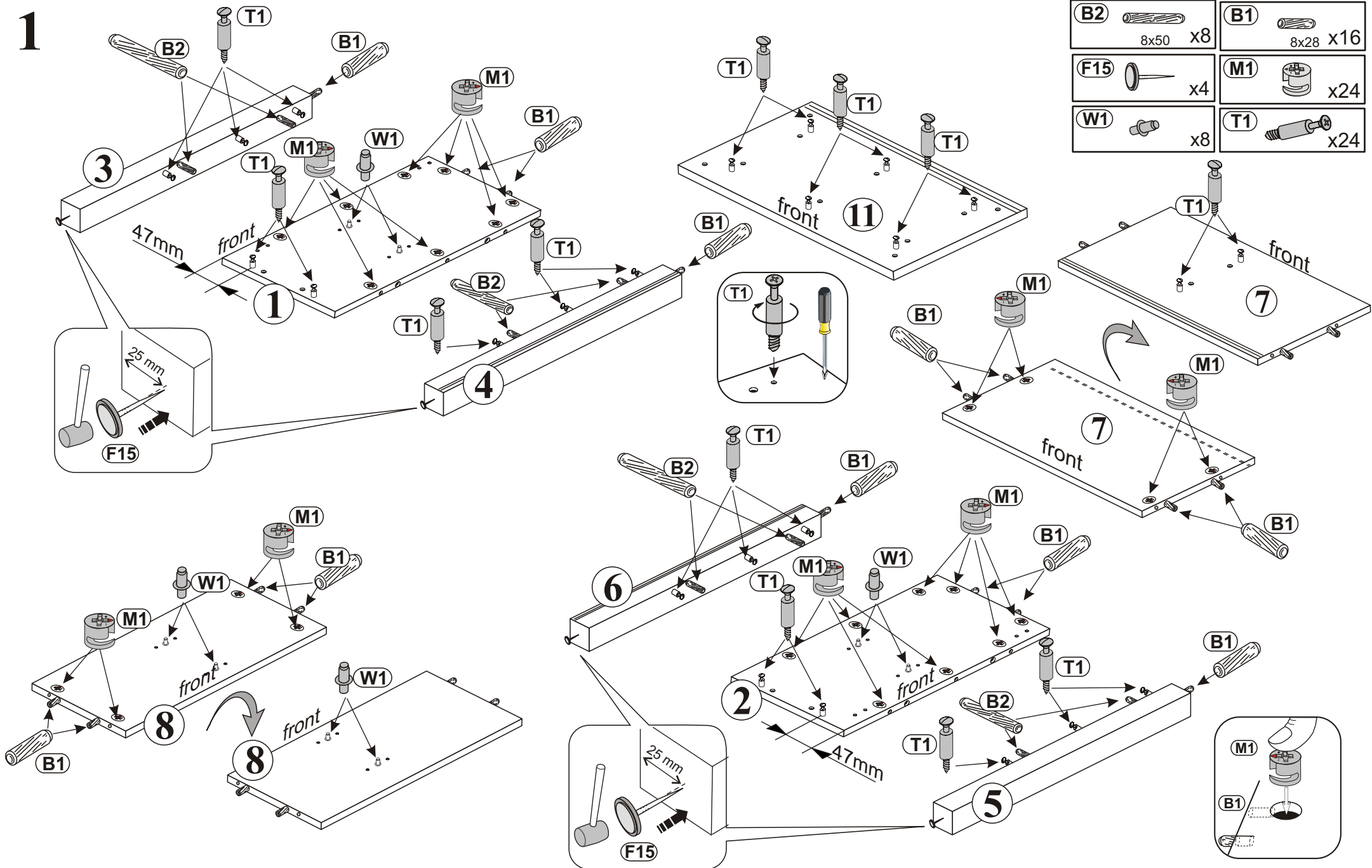

2

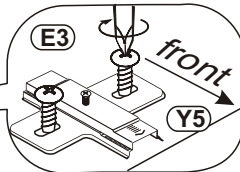
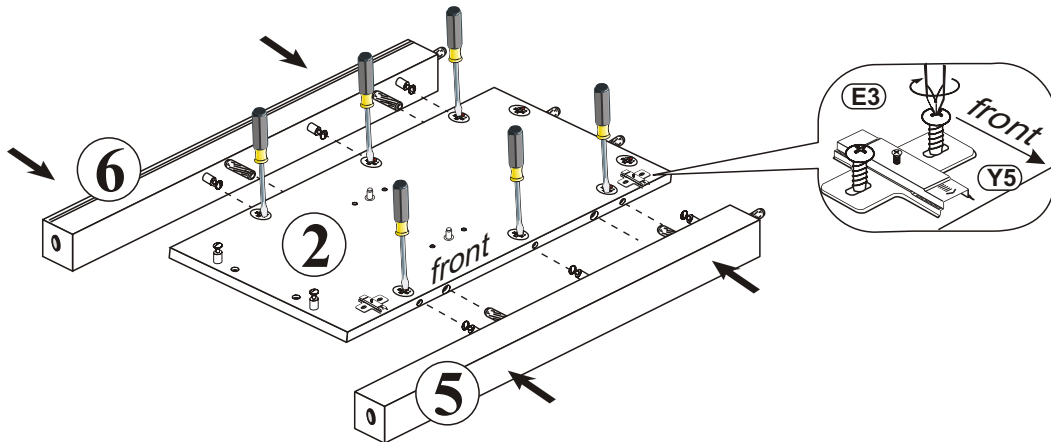
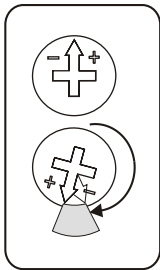
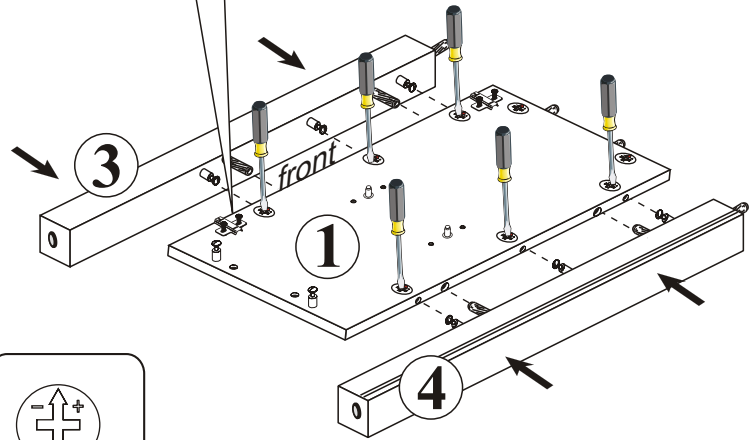
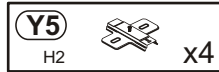
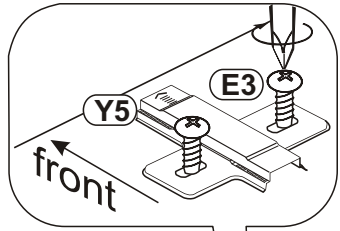

3

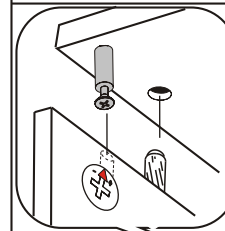
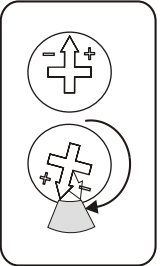
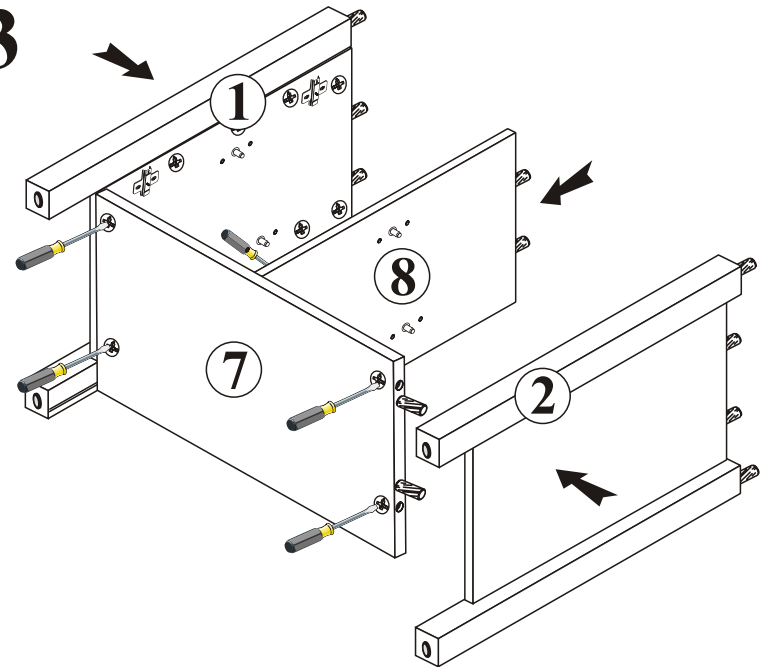

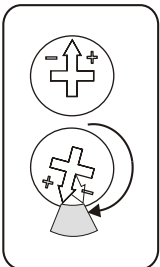
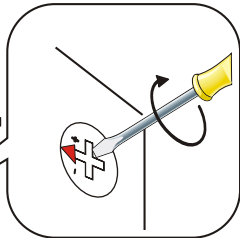
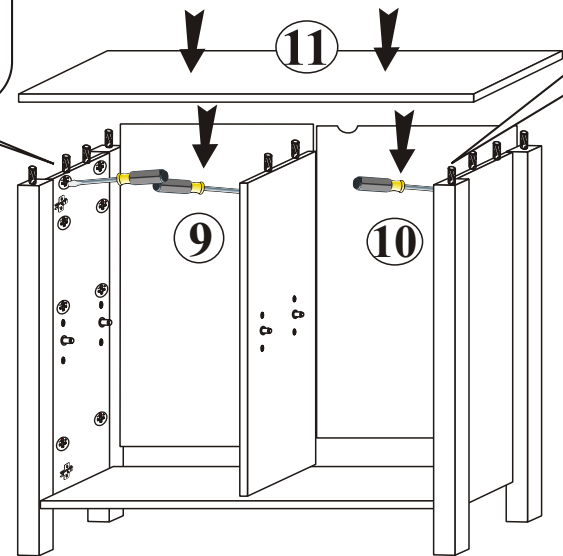

4

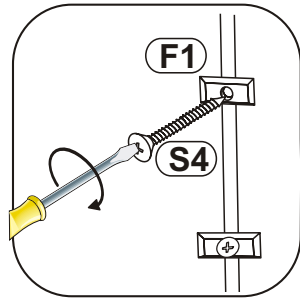

5





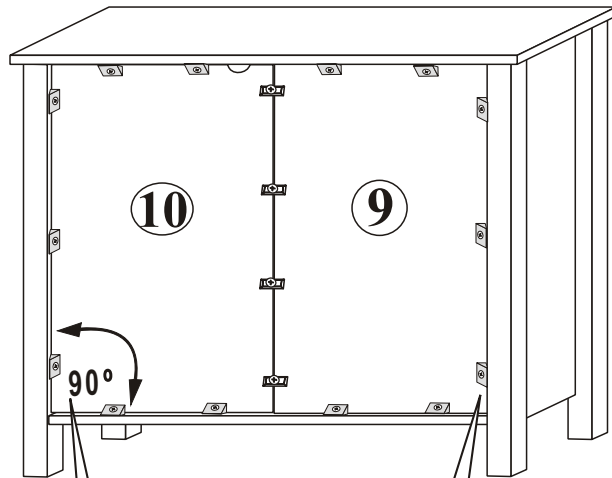

- F1**  x4
- S4**  3,0x20 x4
- J23**  x14

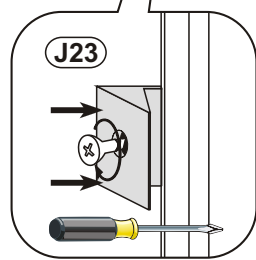
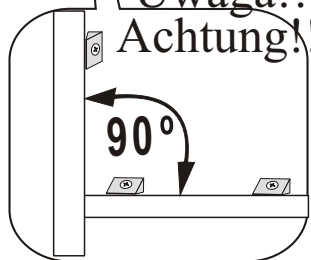

Uwaga!!
Achtung!!



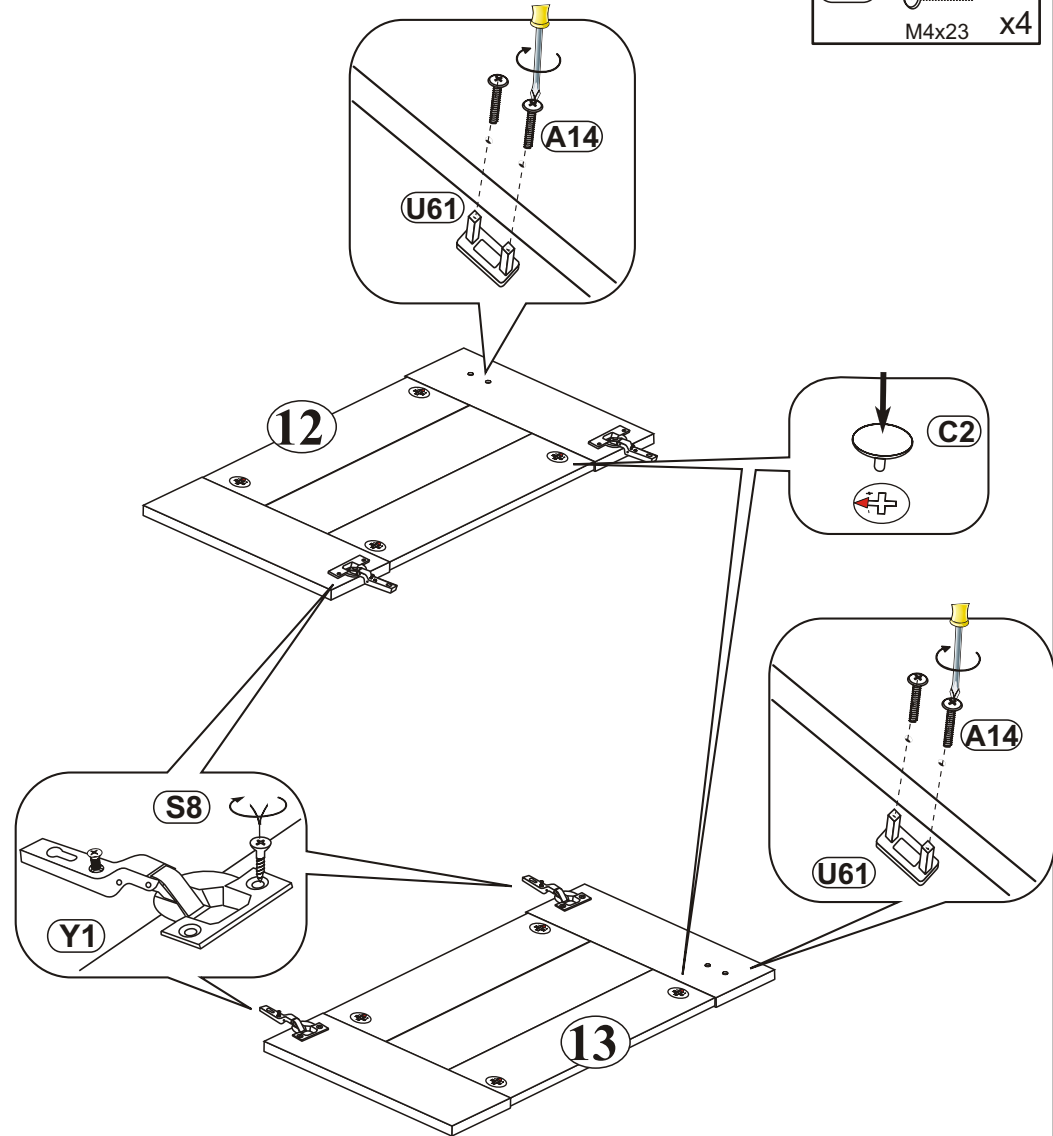

6

- Y1**  26 x4
Kr15
- S8**  4x13 mm x8
- C2**  x8
- U61**  x2
- A14**  M4x23 x4

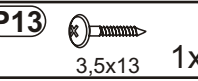

7

- J44**  x1
- P13**  3,5x13 1x
- G22**  x2

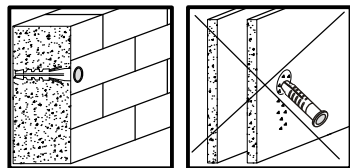
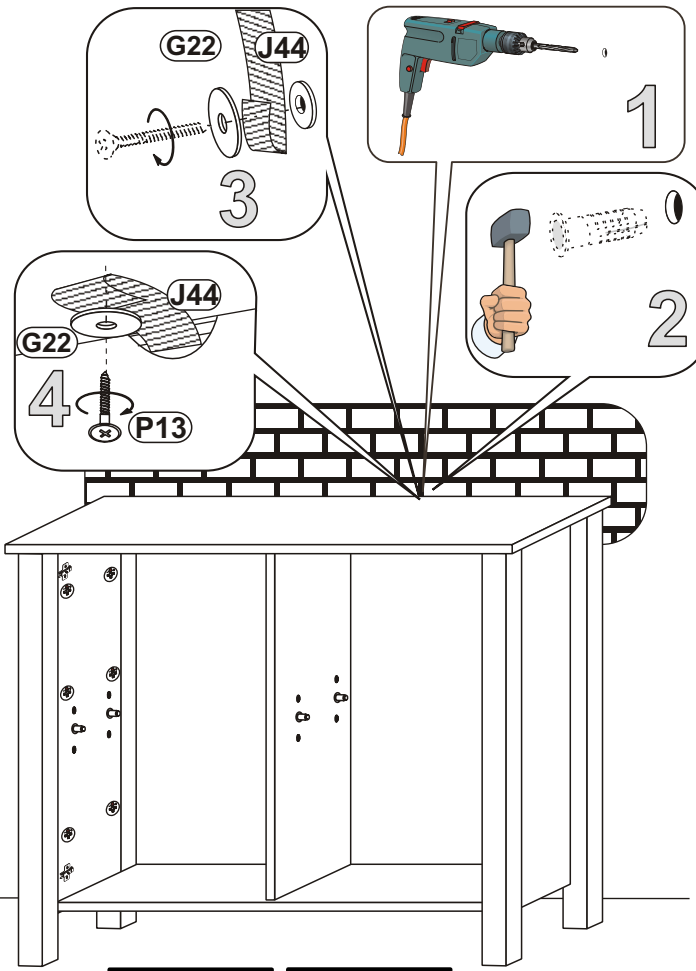

8

- C2**  x20

