





**NR 3**

**U61**  x2

**A14**  M4x23 x4

**NR 1**

**B1**  8x28 x24

**B2**  8x50 x8

**M1**  x26

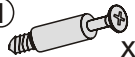
**T1**  x26

**F15**  x4

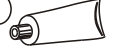
**L1**  x1

**J23**  x4

**NR 2**

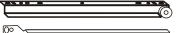
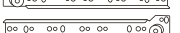
**R23** L-400 mm   
  
  
x2L/2R

**E2**  6x11 x6

**E1**  6x8 x6

**P3**  3,0x13 x8

**S3**  3,5x13 x4

2 Personen  
2 Osoby

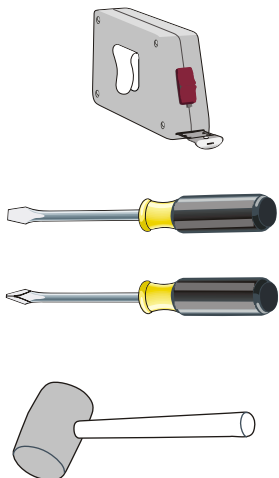

# 1

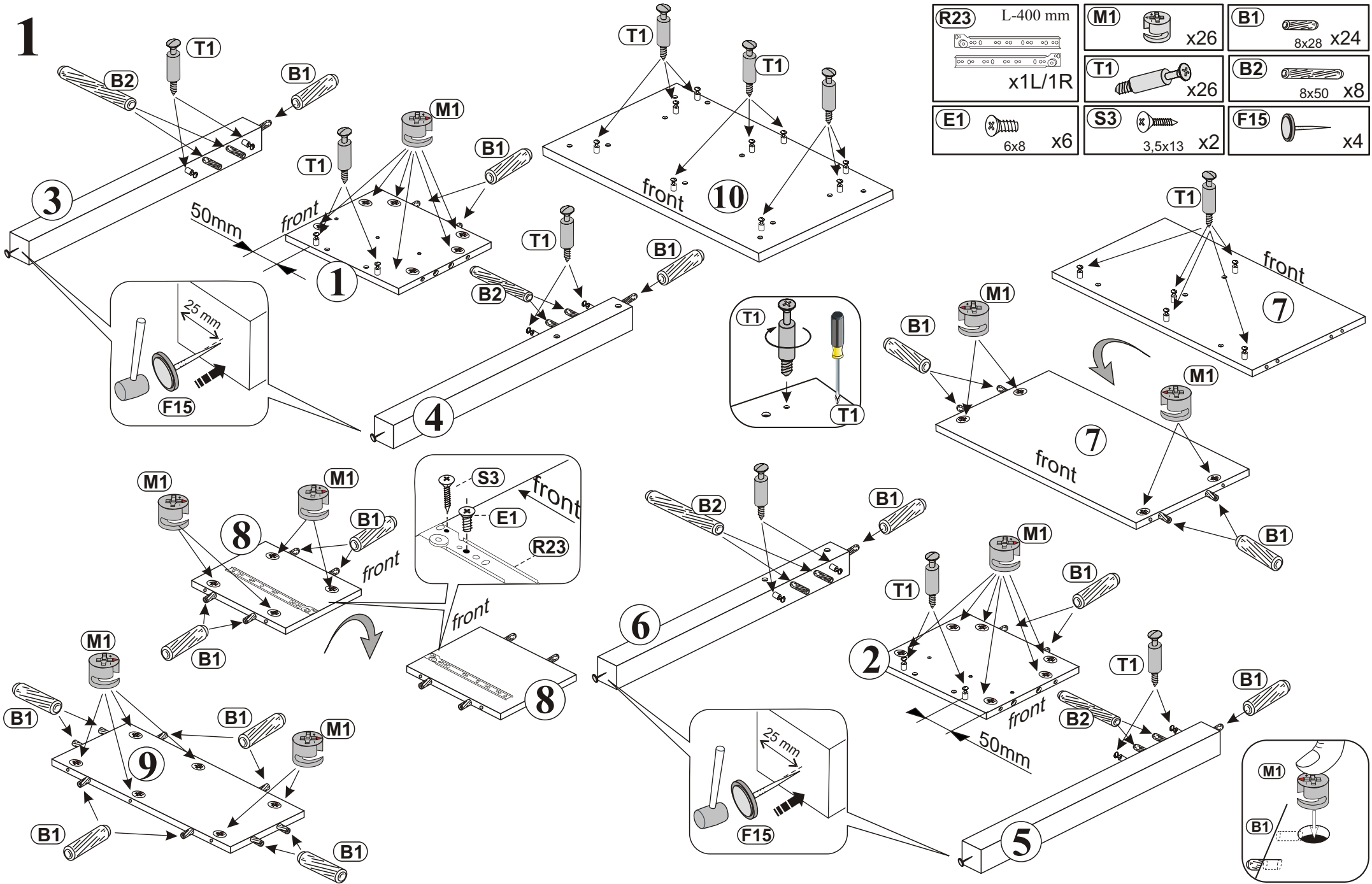

2

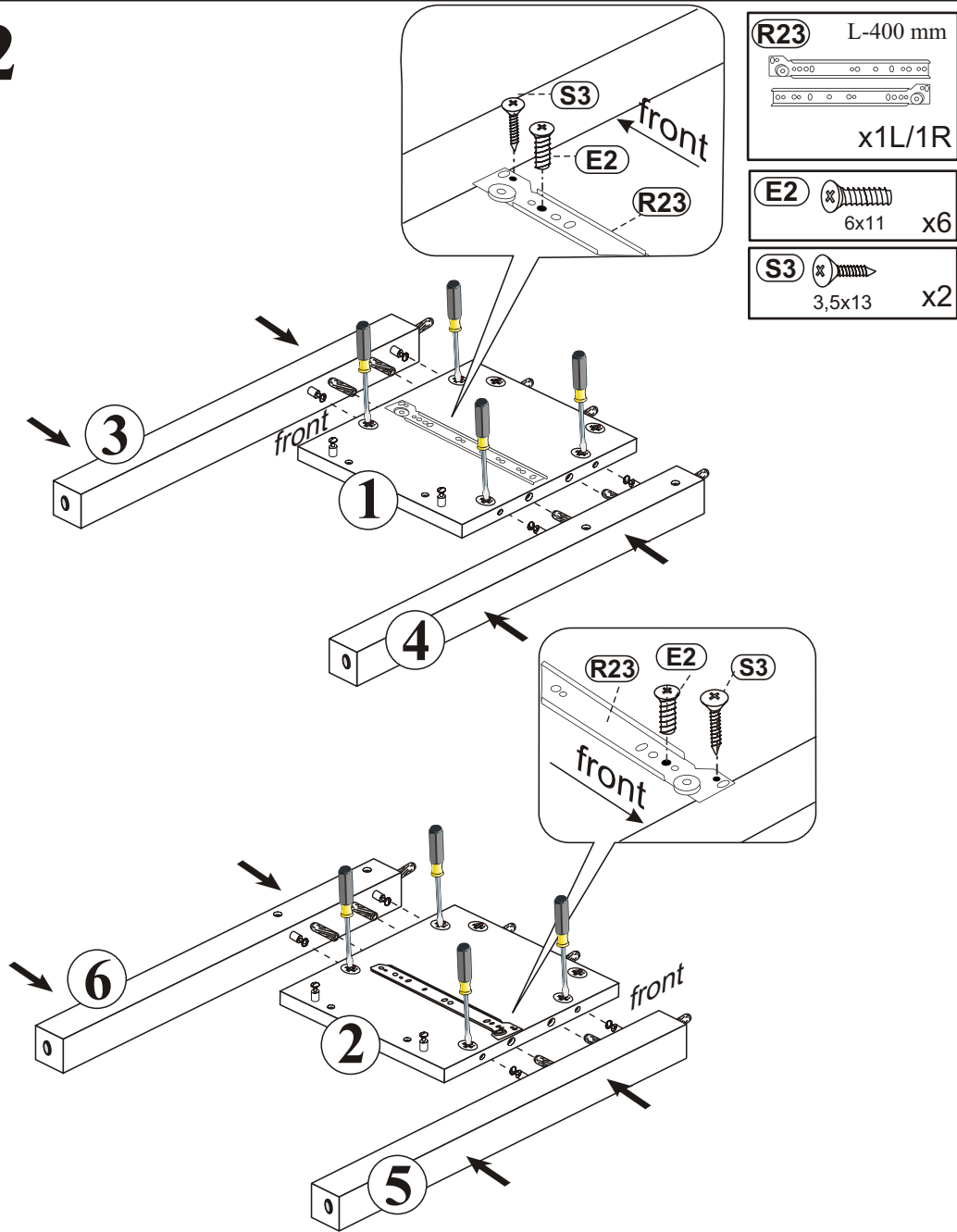

3

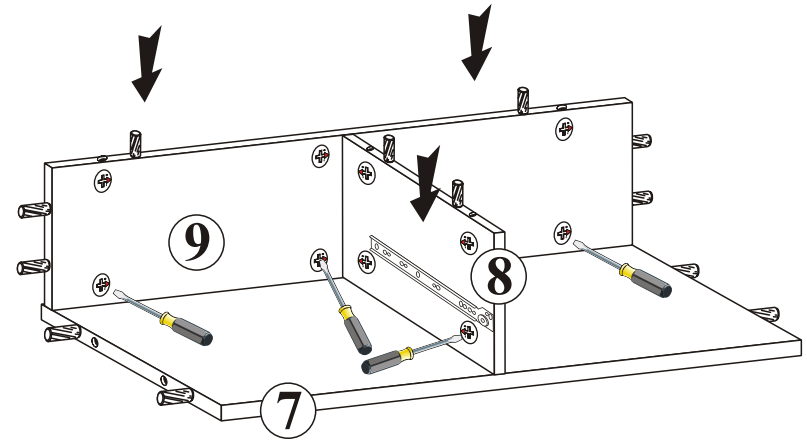

4

