

NR 2

Y1 $\phi 26$
Kr15 x4

Y5 H2 x4

S8 4x13 mm x8

E3 6,3x13 x8

NR 1

B1 $\phi 8 \times 28$ x24

B2 $\phi 8 \times 50$ x8

L1 x1

M1 x28

T1 x28

NR 3

R22 L-350 mm
 x4L/4R

W1 x8

F1 x8

S4 3,0x20 x8

E2 6x11 x24

S3 3,5x13 x8

P3 3,0x13 x16

J23 x18

C2 x16

F15 x6

NR 5

J44 x1

P13 3,5x13 1x

G22 x2

NR 4





U61 x6

A14 M4x23 x12

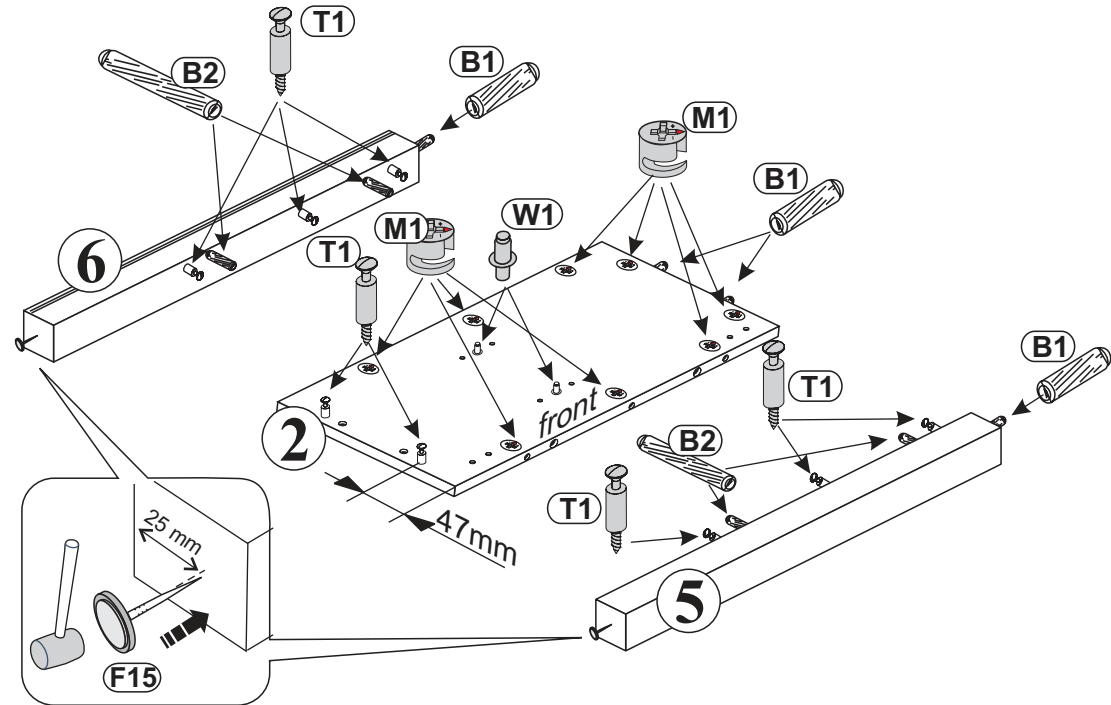
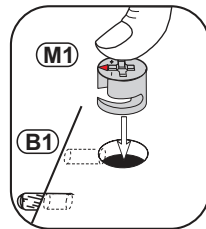
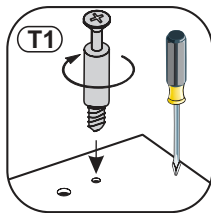
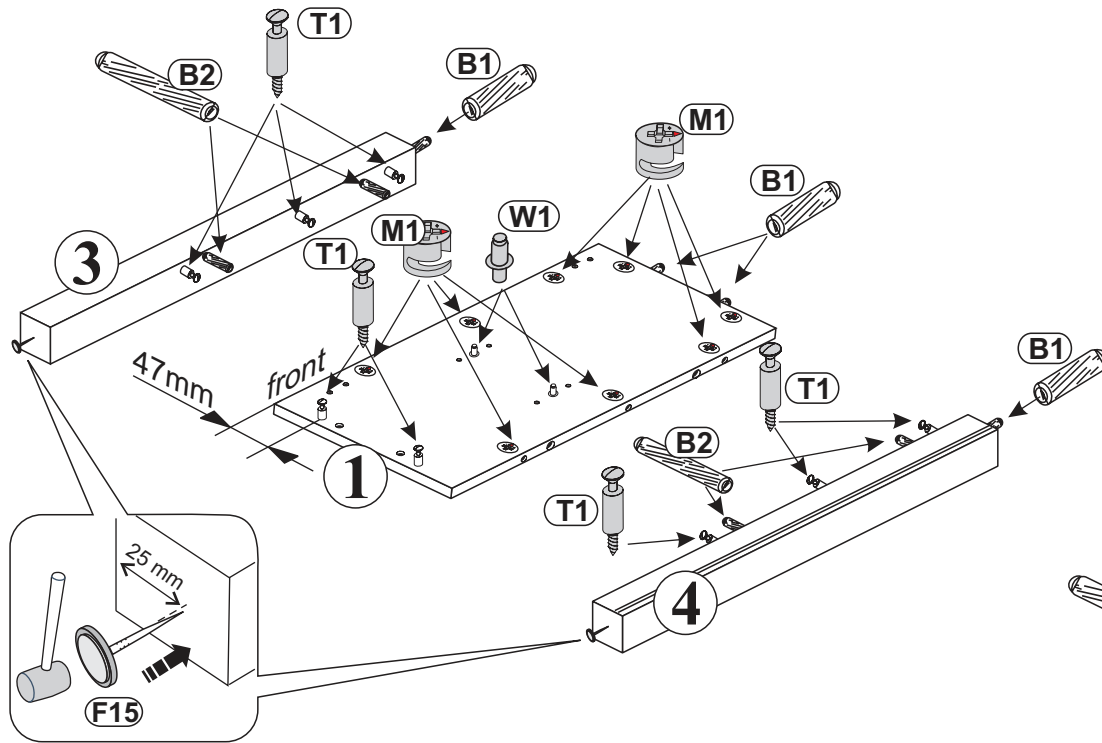

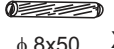
1

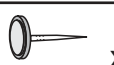

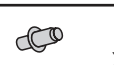
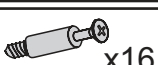
B2	 $\phi 8 \times 50$ x8	B1	 $\phi 8 \times 28$ x8
F15	 x4	M1	 x16
W1	 x4	T1	 x16

2

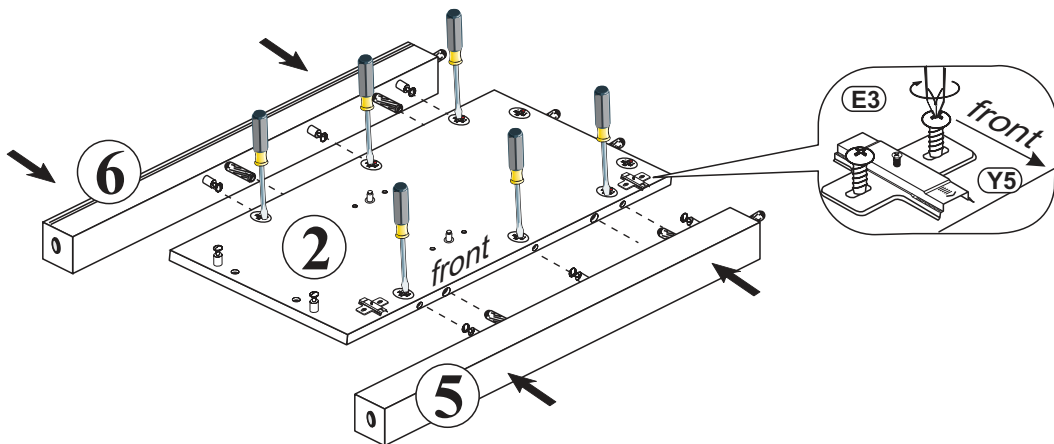
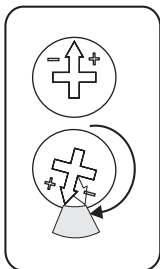
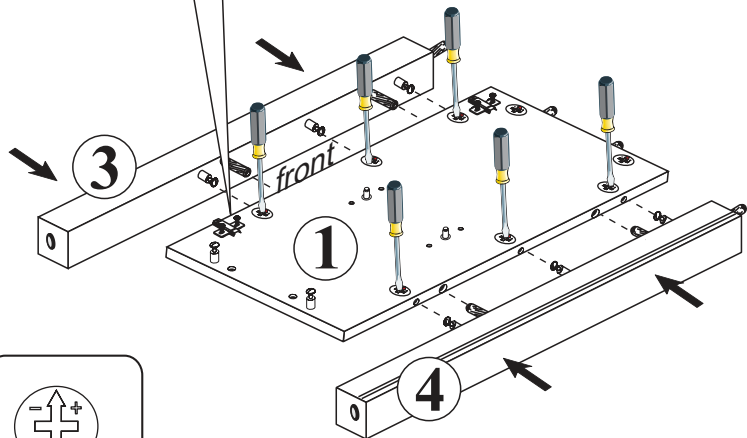
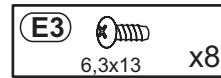
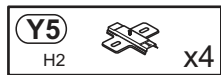
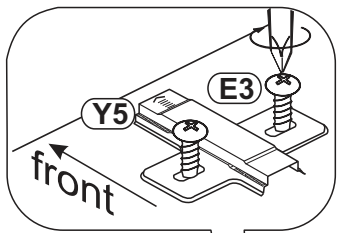

3

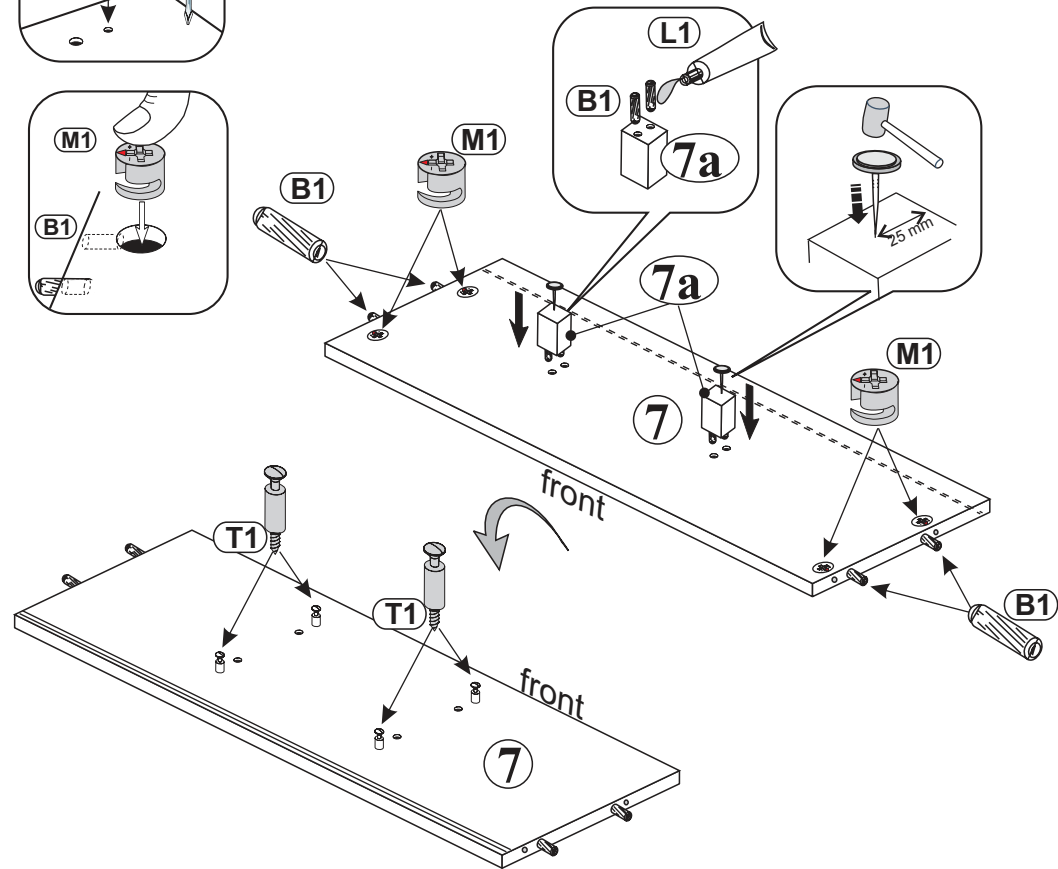
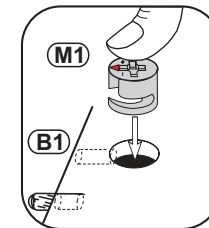
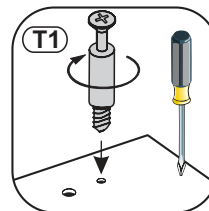
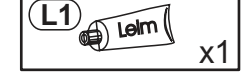
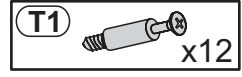
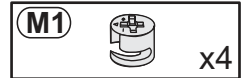
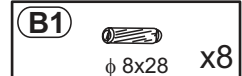
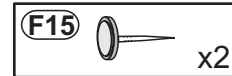
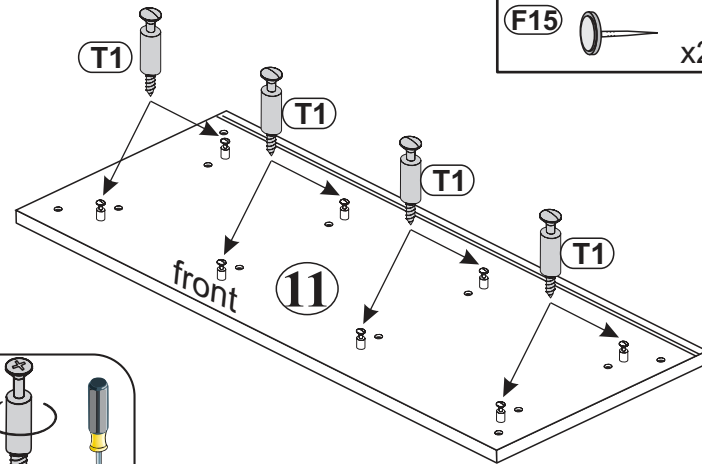

4

- R22** L-350 mm x4L/4R
- B1** ϕ 8x28 x8
- M1** x8
- E2** 6x11 x24
- W1** x4
- S3** 3,5x13 x8

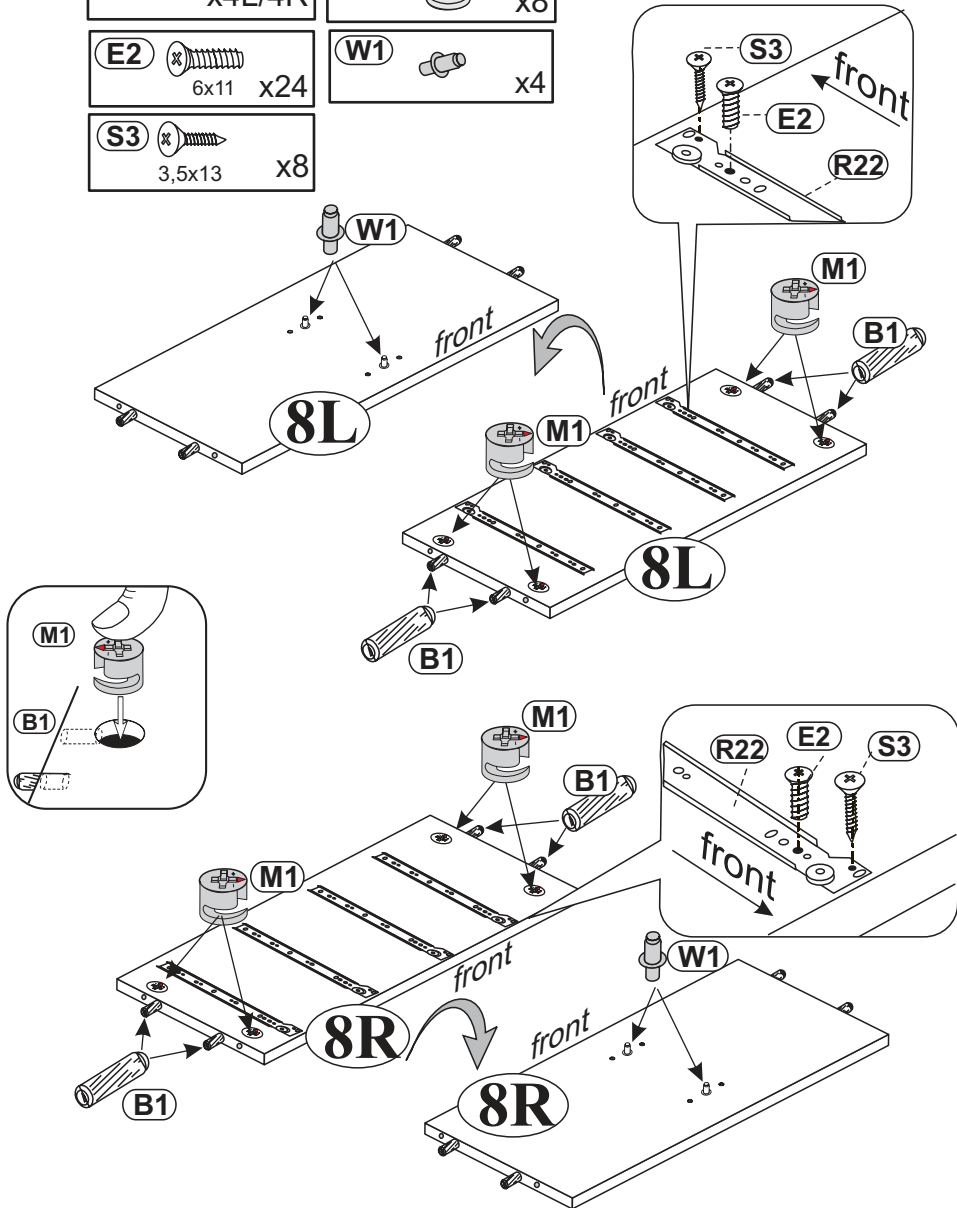

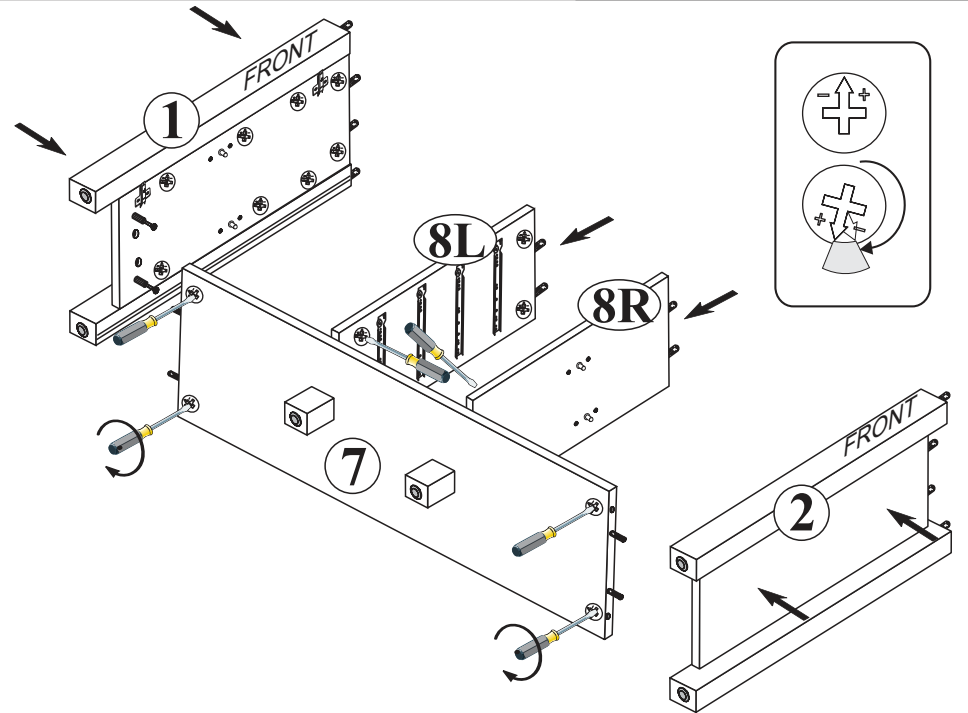

5

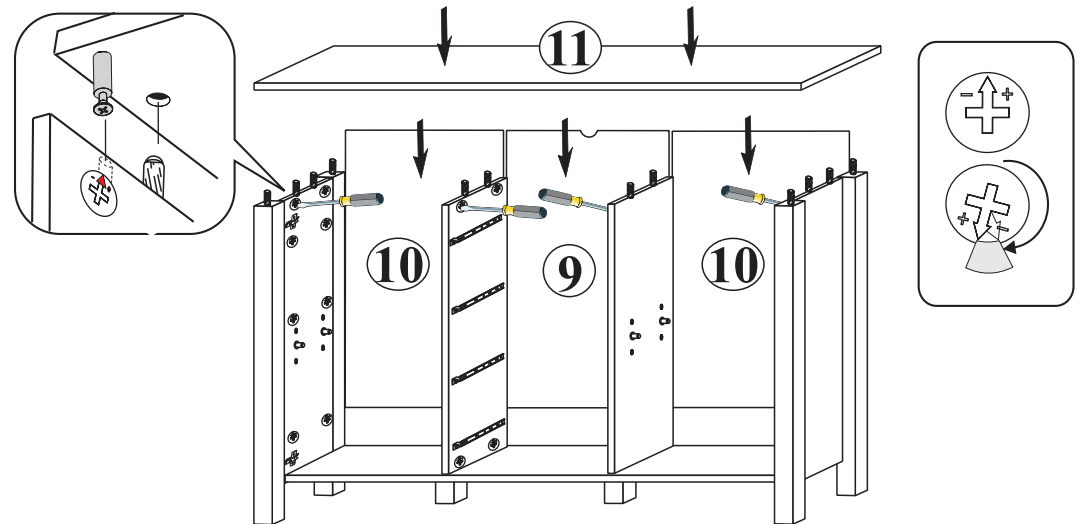

6



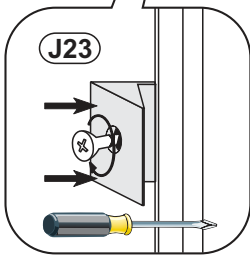
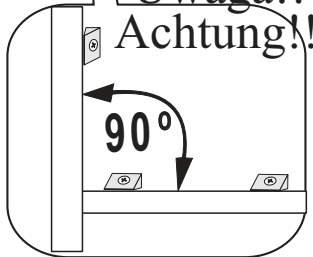
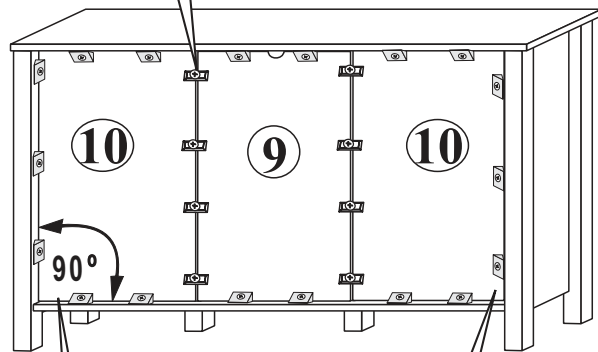
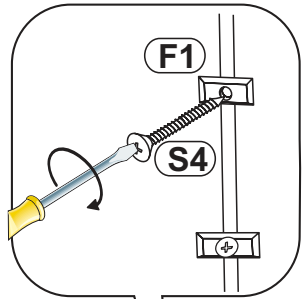

7

- F1**  x8
- S4**  3,0x20 x8
- J23**  x18



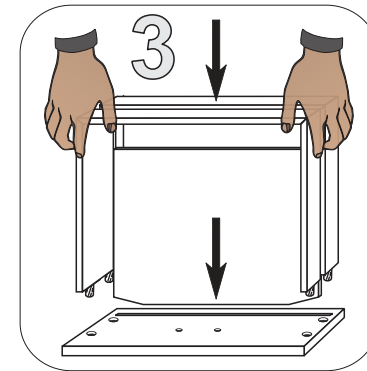
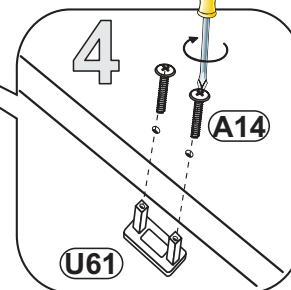
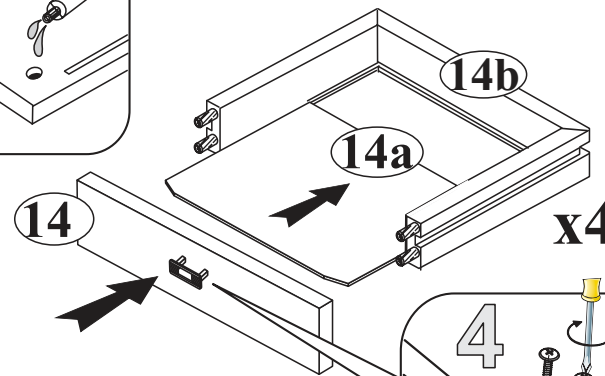
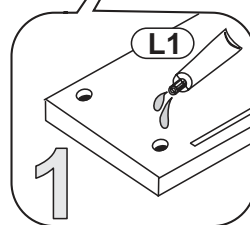
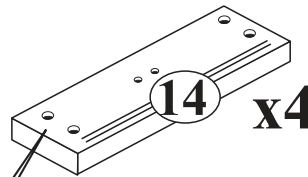
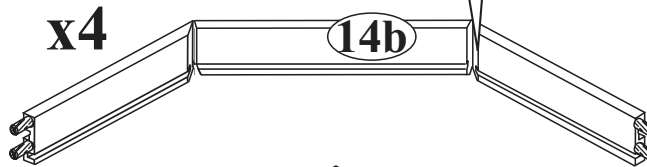
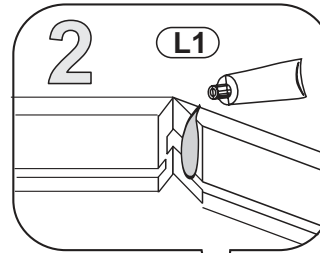

8

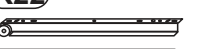

- U61**  x4
- A14**  M4x23 x8

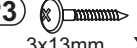
- R22** L-350 mm  x4L/4R

- P3**  3x13mm x16

- L1**  x1

- J23**  x8

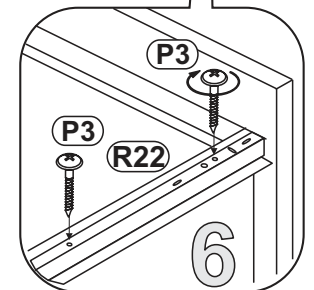
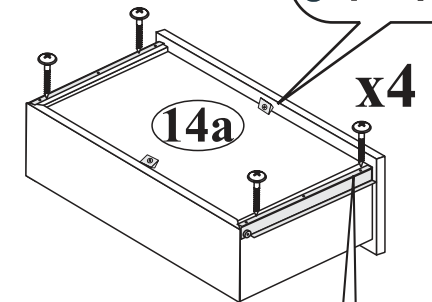
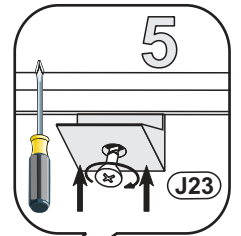

9

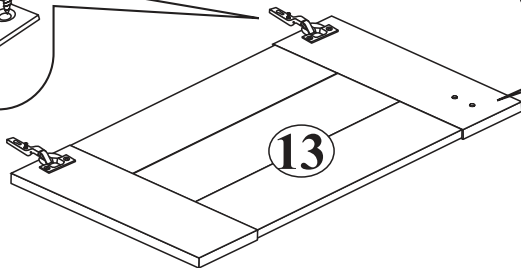
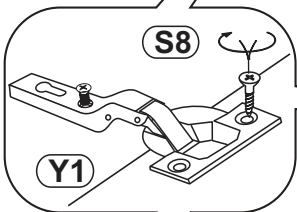
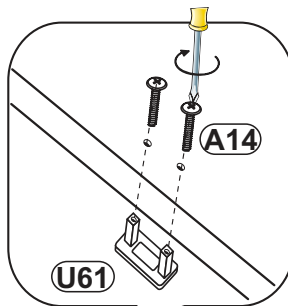
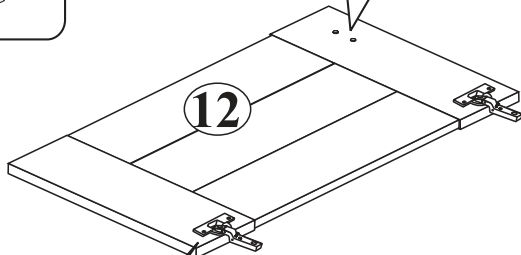
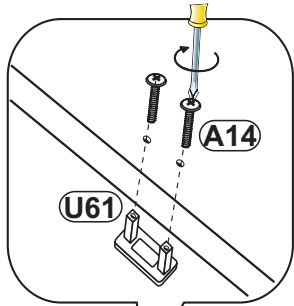
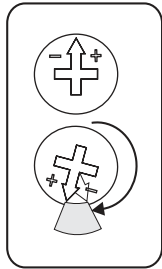
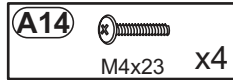
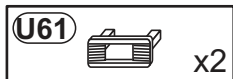
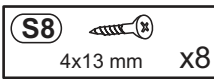
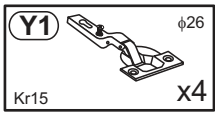

10

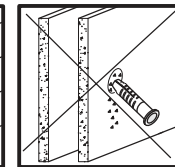
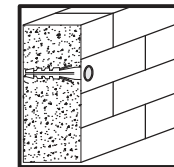
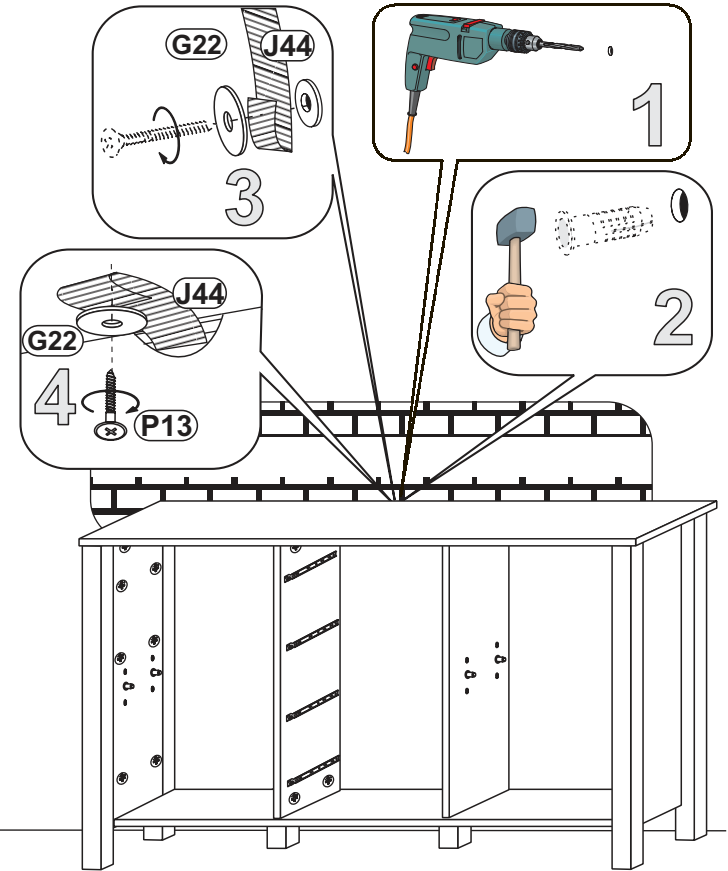
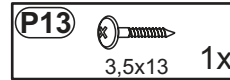
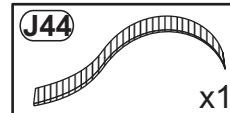

11

