

# LINATE TYP 22A

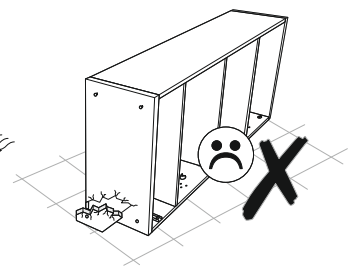

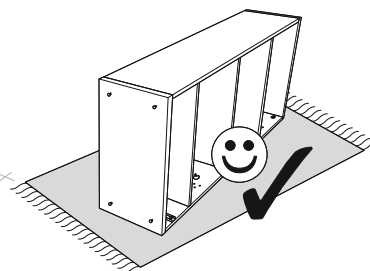
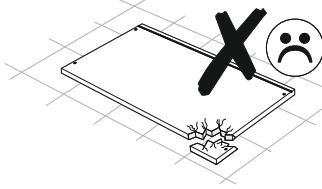
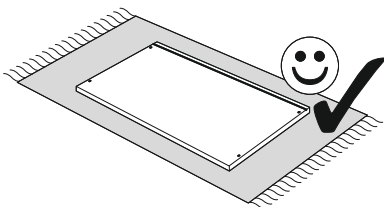
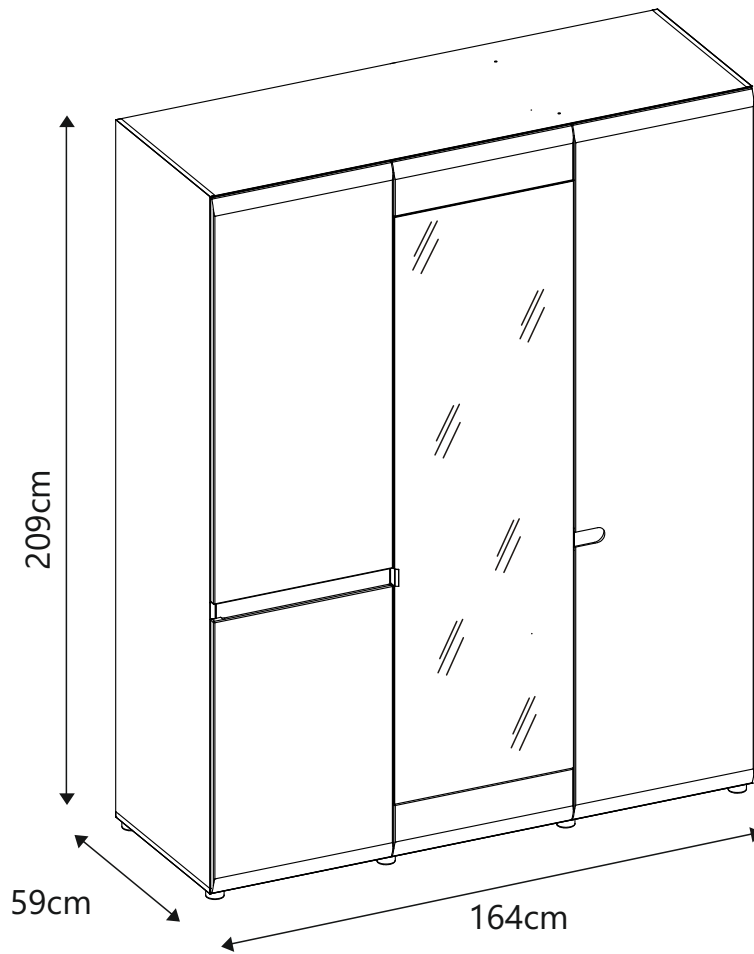
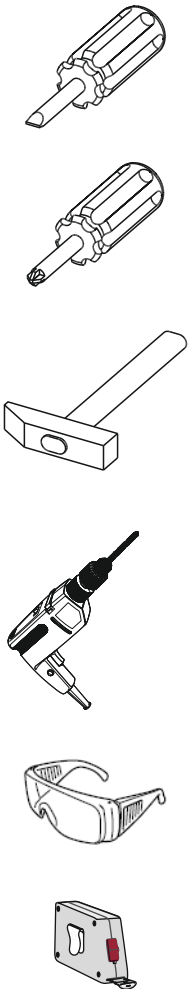
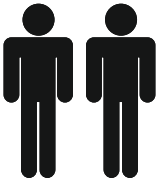
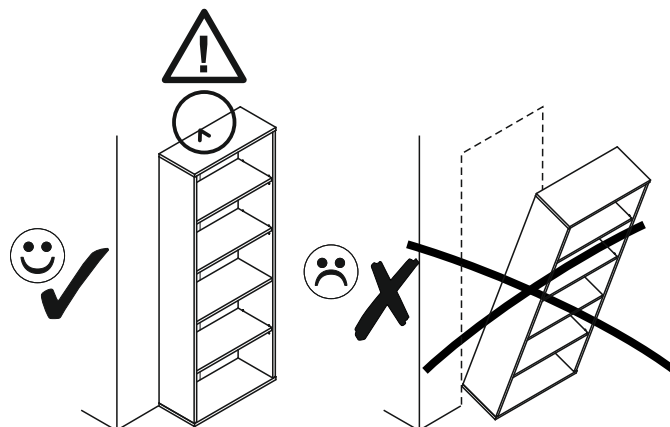

PL.  
 UWAGA! Mebel należy trwale zamocować do ściany, aby uniknąć ryzyka związanego z przewróceniem się mebla.  
 W paczce nie ma śrub mocujących, ponieważ rodzaj mocowania należy odpowiednio dobrać do rodzaju ściany. Dobierz właściwe do Twojego rodzaju ściany.

SK.  
 POZOR! Nábytok musí byť trvalo pripevnený k stene tak, aby sa zamedzilo riziku prevrátenia. Balík neobsahuje upevňovacie skrutky, pretože typ upevnenia je treba vybrať podľa typu steny. Vyberte typ vhodný pre Vašu stenu.

FR.  
 ATTENTION! Ce meuble doit être fixé en permanence au mur pour éviter les risques de chute. Les vis de fixation ne sont pas livrées car le type de fixation doit être choisi en fonction du type de mur. Sélectionnez les fixations adaptées au mur.

HU.  
 FIGYELEM! Rögzítse a bútorokat a falhoz, hogy elkerülje a bútor felborulásának kockázatát. A készletben nem találhatóak rögzítőcsavarok, mivel a rögzítés típusa a fal típusától függ. Válassza ki a fal típusának megfelelő kötőelemeket.

HR.  
 NAPOMENA! Namještaj mora biti trajno pričvršćen za zid, kako bi se izbjegao rizik od njegova prevrtanja. U paketu nema vijaka za pričvršćivanje, jer se vrsta montaže mora prilagoditi vrsti zida. Odaberite pravu vrstu prema Vašoj vrsti zida.

EN.  
 WARNING! To prevent this furniture from tripping over, fix it to the wall permanently. Fixing devices are not included since different wall materials require different types of fixing devices. Please make sure you chose the correct ones for your type of wall.

D.  
 ACHTUNG! Um alle mit dem Umkippen des Möbels verbundenen Risiken auszuschließen, muss das Möbel fest an der Wand verankert werden. Beschläge für die Wandbefestigung sind nicht beige packt, da diese von der jeweiligen Wandbeschaffenheit abhängig sind. Bitte solche Befestigungsschläge wählen, die für die heimischen Wände geeignet sind.

CZ.  
 POZOR! Nábytek je nutné pevně připevnit ke zdi, abychom se vyhnuli riziku spojenému s jeho převrhnutím. Součástí balení nejsou připevňovací šrouby, protože způsoby připevnění je nutné zvolit podle druhu stěny. Vyberte správný pro Váš typ stěny.

E.  
 ¡ATENCIÓN! El mueble debe ser fijado permanentemente a la pared para evitar el riesgo relacionado con el vuelco del mueble. En el paquete no hay tornillos de fijación, ya que se debe elegir el tipo de fijación adecuado para el tipo de pared. Elija el apropiado para su tipo de pared.

CN.  
 注意！本家具需要固定在墙上以免倒塌。箱子里没有安装螺钉，因为安装方式需要根据墙的类型调整。请按照您的墙类型选择合适的安装方式。

RU.  
 ПРИМЕЧАНИЕ! Эту мебель необходимо всегда прикреплять к стене, чтобы избежать рисков, связанных с переворотом мебели. В пакете нет крепежных винтов, потому что тип крепления должен быть выбран в соответствии с типом стены. Выберите, пожалуйста, правильные винты к вашей стене.





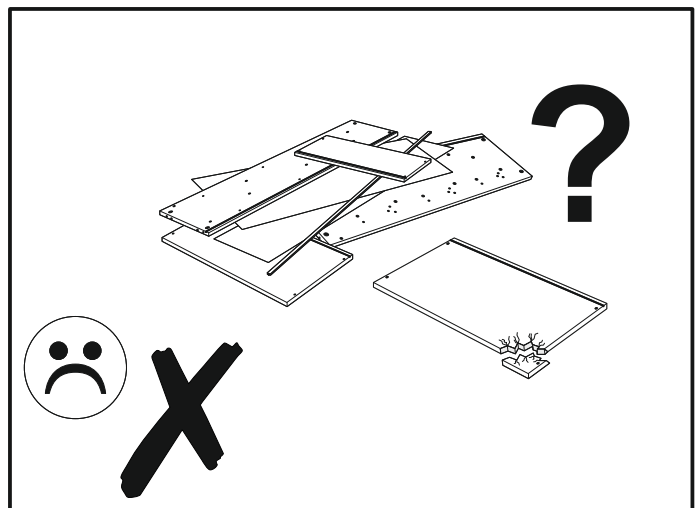
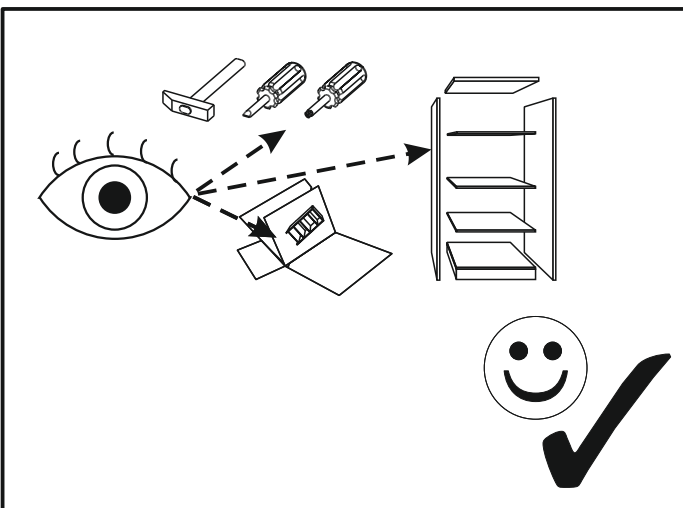
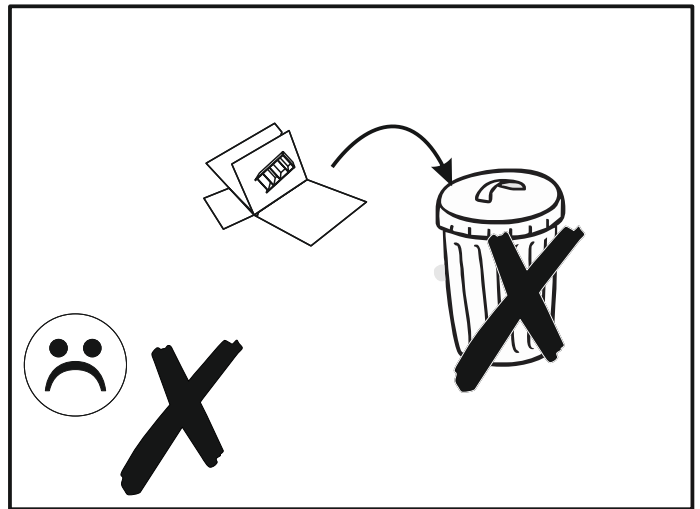
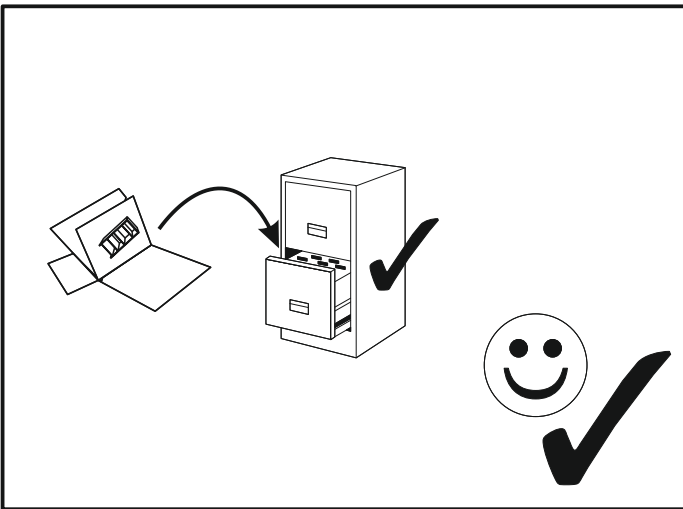
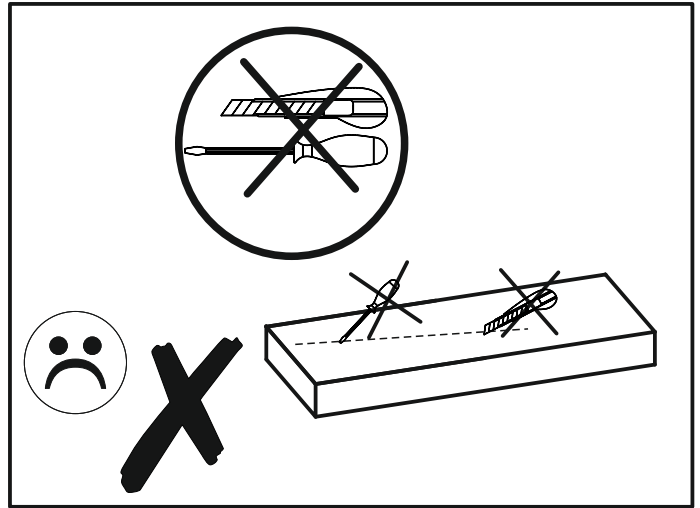
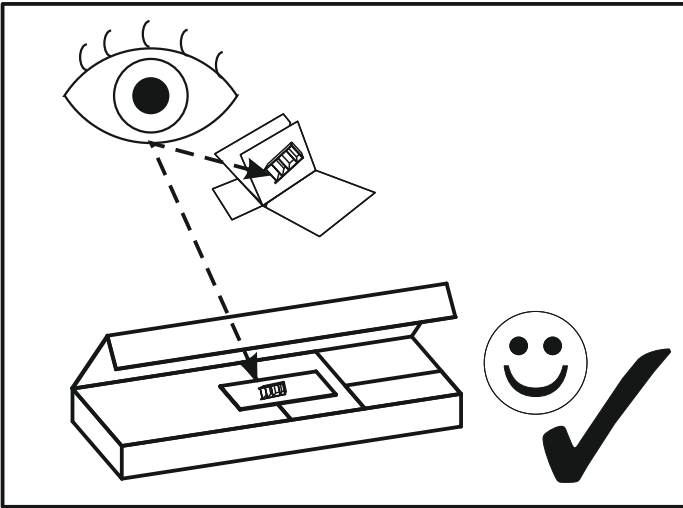



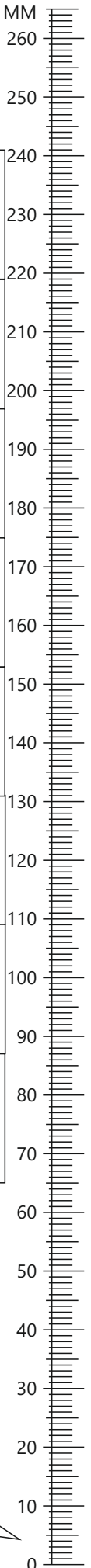

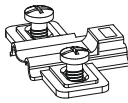
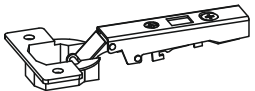
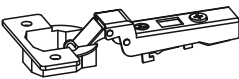





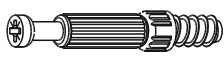

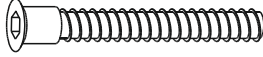
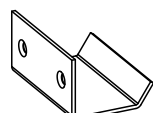

SLO.  
 POZOR! Pohištvo trajno pritrdite na steno, da preprečite tveganje, da se prevrne. V paketu ni pritrdilnih vijakov, saj je treba način pritrditve ustrezno izbrati glede na vrsto stene. Izberite način, ki je ustrezen za vašo steno.

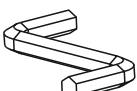
I.  
 ATTENZIONE! Il mobile deve essere permanentemente fissato alla parete per evitare i rischi derivanti da un ribaltamento del mobile. La confezione non include le viti di fissaggio, in quanto il tipo di fissaggio deve essere scelto in base al tipo di parete. Utilizzare viti appropriate in base al materiale della parete.

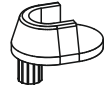

# LINATE TYP 22A

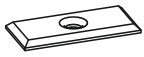

<p><b>A1</b> x22 <math>\phi 8 \times 35\text{mm}</math></p> 	<p><b>BC10</b> x12</p> 	<p><b>BC11</b> x8</p> 
<p><b>BC12</b> x4</p> 	<p><b>C1</b> x24 <math>4 \times 13\text{mm}</math></p> 	<p><b>D2</b> x16</p> 
<p><b>E0a</b> x4</p> 	<p><b>E0b</b> x4</p> 	<p><b>E1</b> x8 <math>\phi 15 \times 12\text{mm}</math></p> 
<p><b>F1</b> x8 <math>\phi 6 \times 34\text{mm}</math></p> 	<p><b>G0</b> x8</p> 	<p><b>G1</b> x8 <math>\phi 7 \times 50\text{mm}</math></p> 
<p><b>H1</b> x1 t</p> 	<p><b>I2</b> x1 <math>4 \times 16\text{mm}</math></p> 	<p><b>I5</b> x12 <math>4 \times 30\text{mm}</math></p> 
<p><b>I10</b> x8 <math>3,5 \times 22\text{mm}</math></p> 	<p><b>M</b> x1</p> 	<p><b>N1</b> x20 <math>3 \times 16\text{mm}</math></p> 
<p><b>N2</b> x2 <math>3,5 \times 16 \text{ mm}</math></p> 	<p><b>O15</b> x8 <math>\phi 50 \times 25</math></p> 	<p><b>P4</b> x4</p> 
<p><b>Q9</b> x1</p> 	<p><b>R1</b> x13</p> 	<p><b>R4</b> x24</p> 
<p><b>Z1</b> x2</p> 		

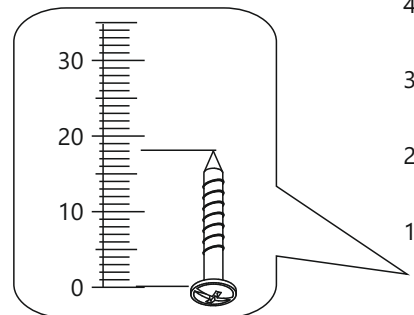

# LINATE TYP 22A

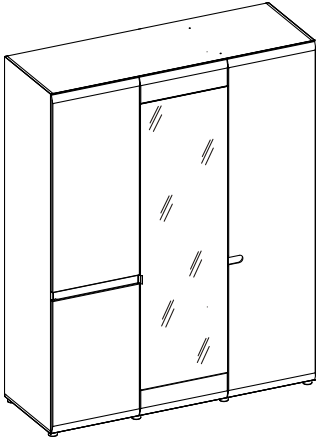

1	2050	570	16	x1	4/4
2	2033	550	16	x1	3/4
3	2050	570	16	x1	4/4
4	1607	570	16	x1	3/4
5	528	534	16	x1	1/4
6	1607	168	16	x1	3/4
7	1640	570	16	x1	3/4
8	1200	548	19	x3	1/4
9	532	100	16	x1	3/4
10	811	548	19	x1	1/4
11	2061	532	19	x1	2/4
12	2061	548	19	x1	2/4
13	100	96	16	x1	3/4
14	2047	1076	4	x1	4/4
15	2047	543	4	x1	4/4

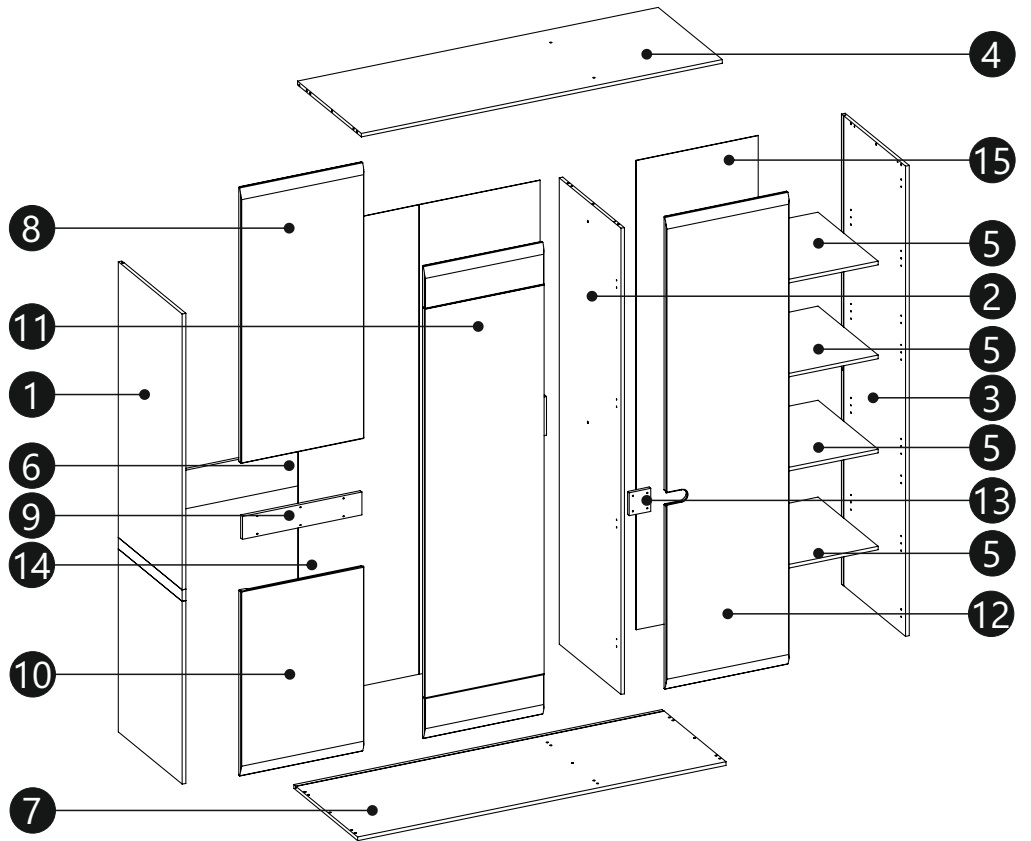

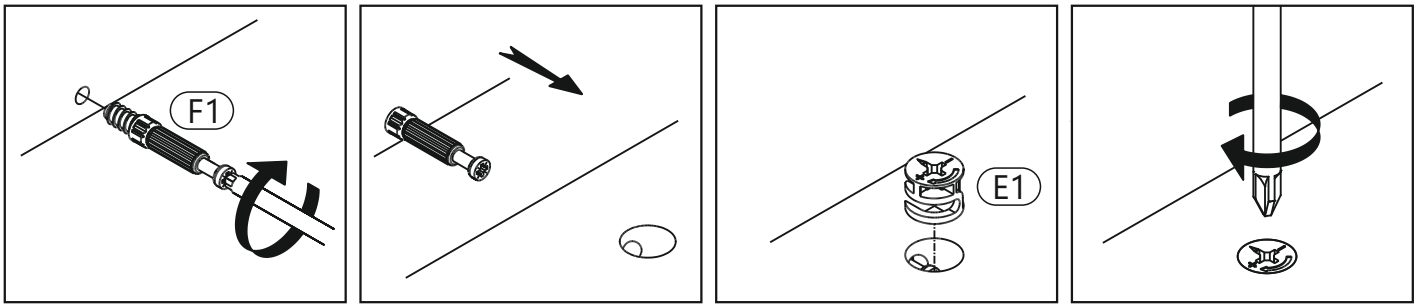

1 ▶

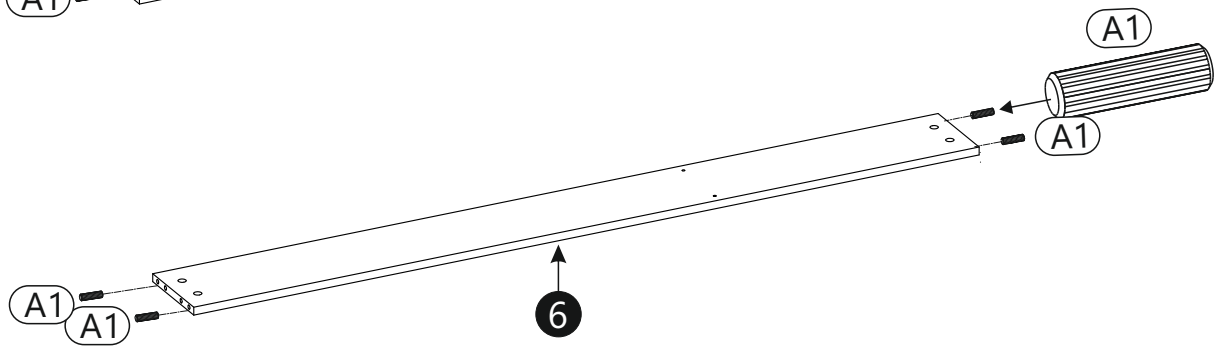
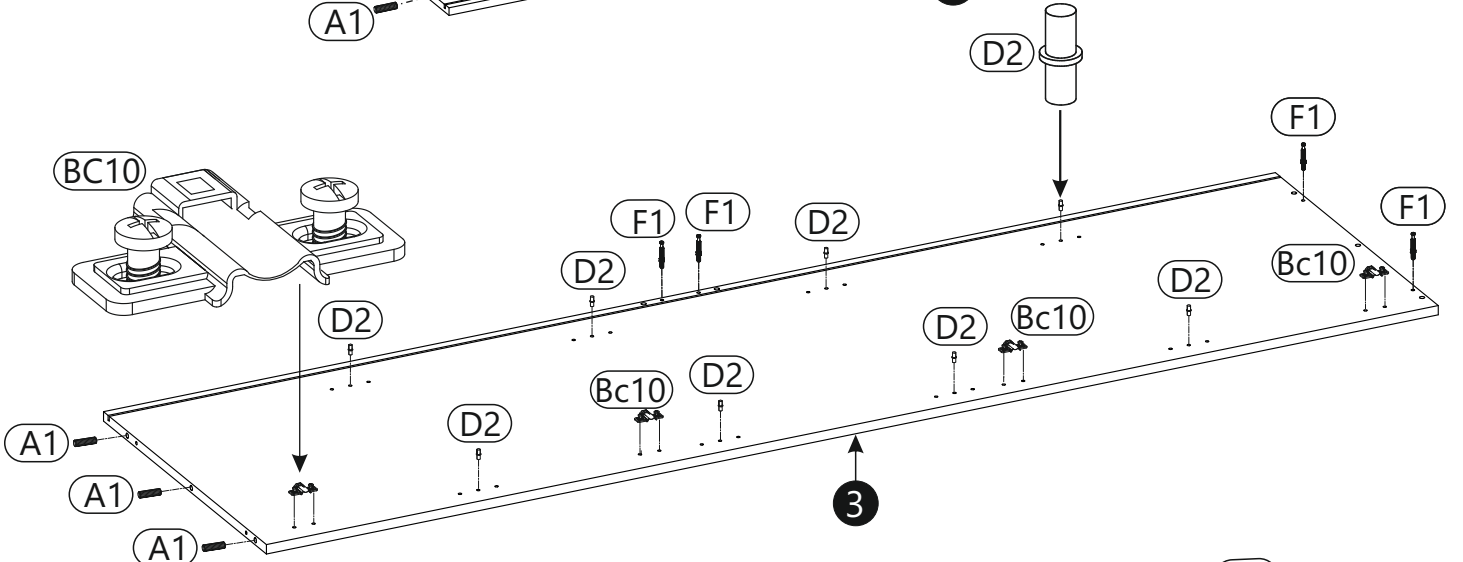
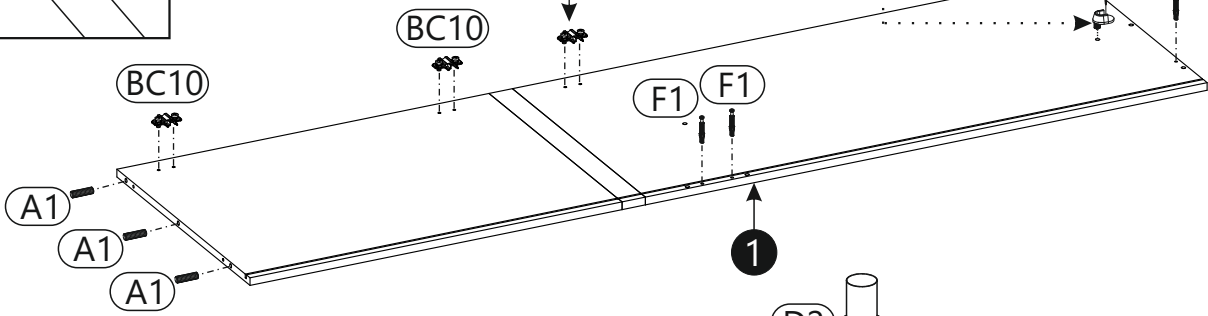
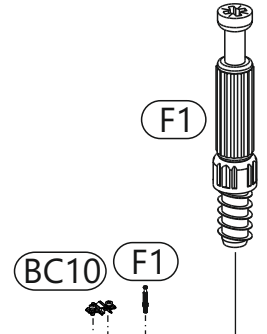
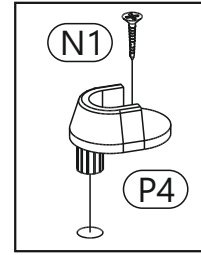
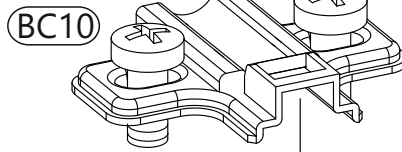
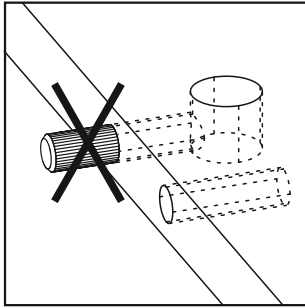
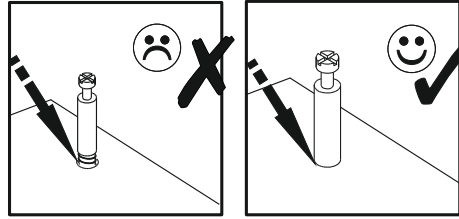

2 ▶

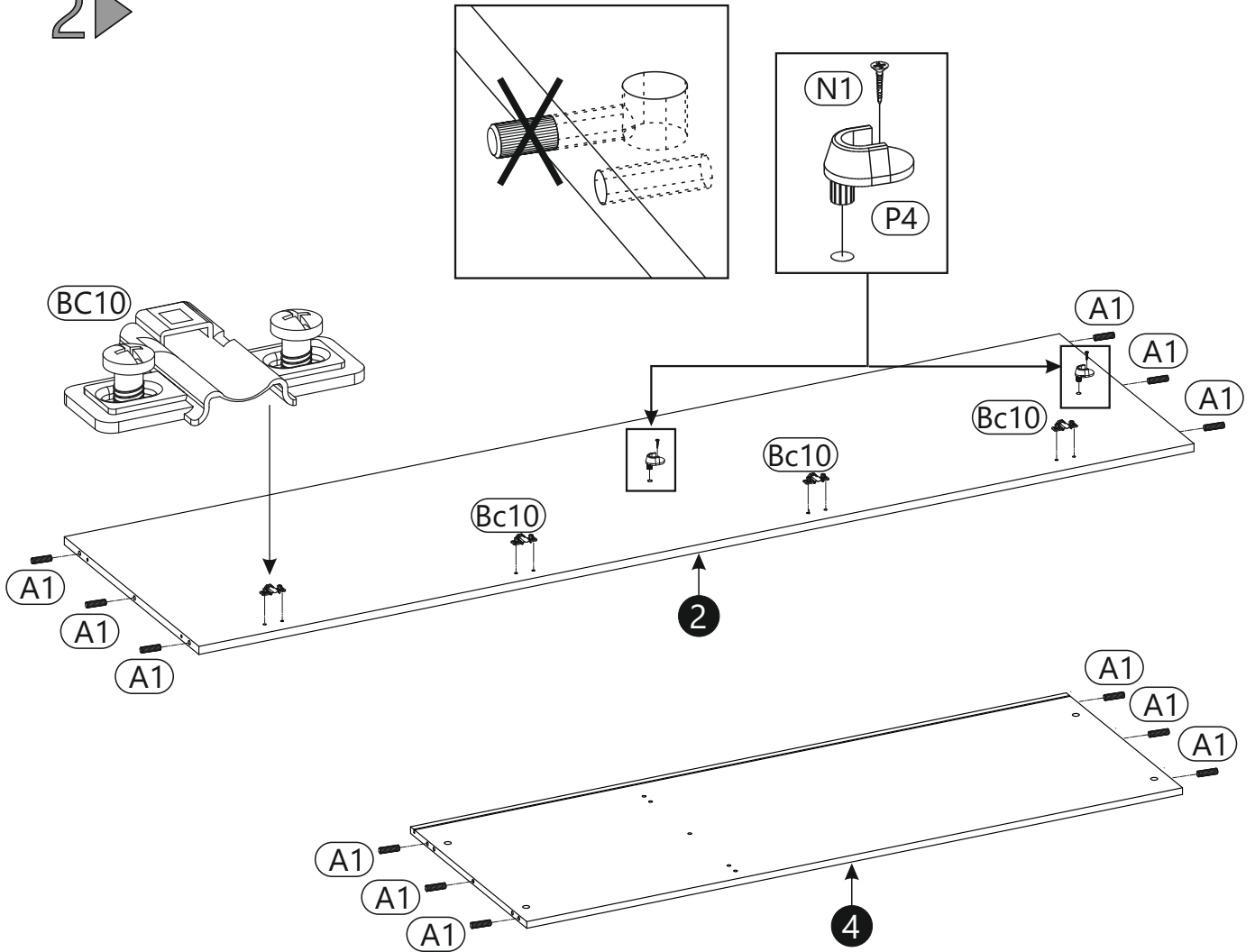

3 ▶

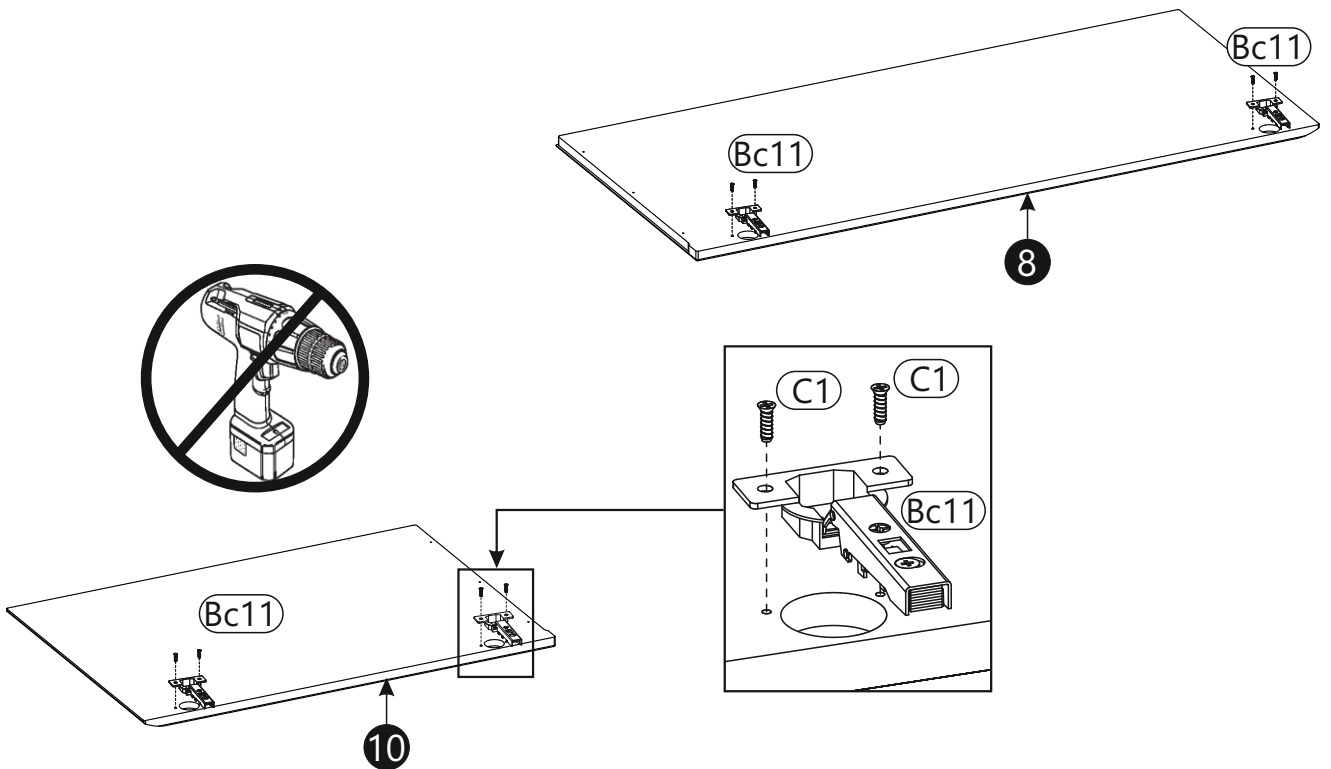

4 ▶

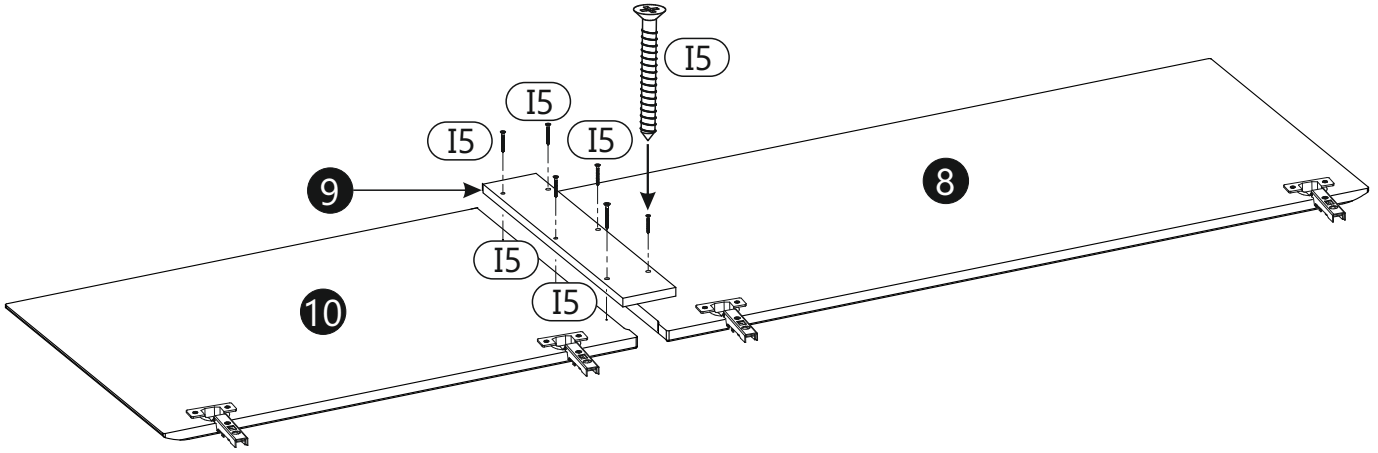

5 ▶

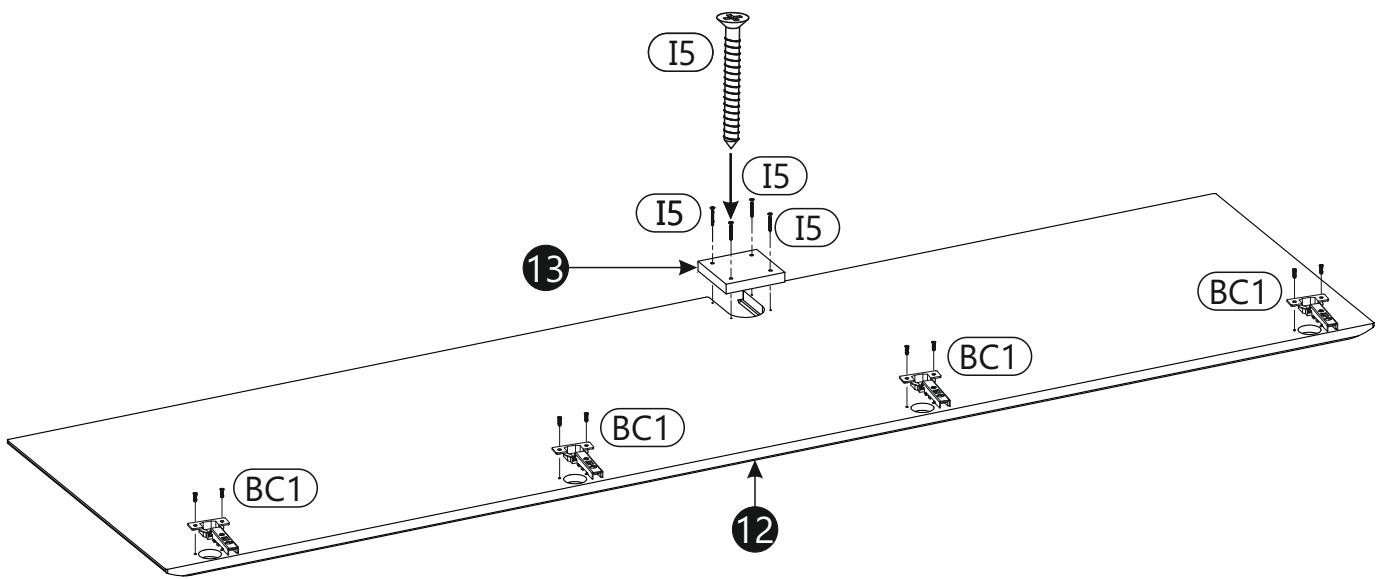
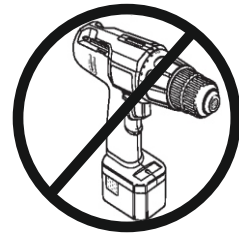



6 ▶

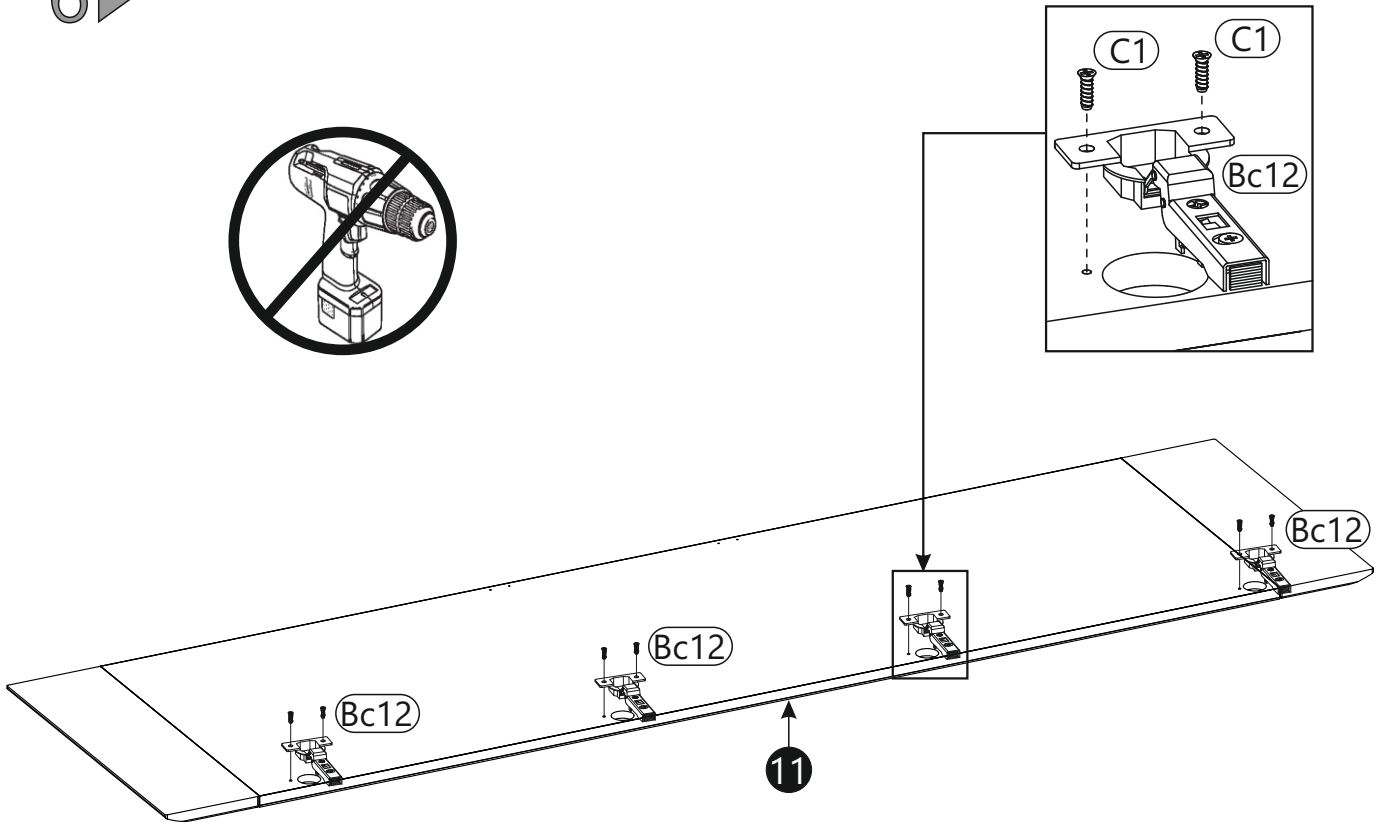
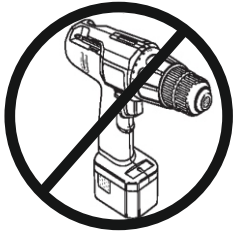

7 ▶

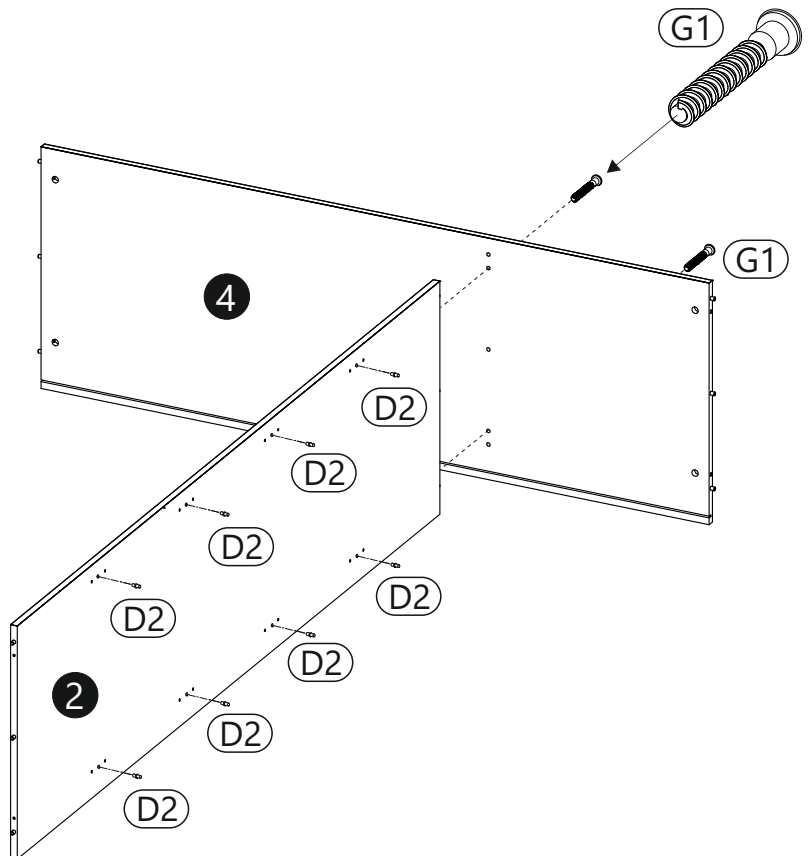

8 ▶

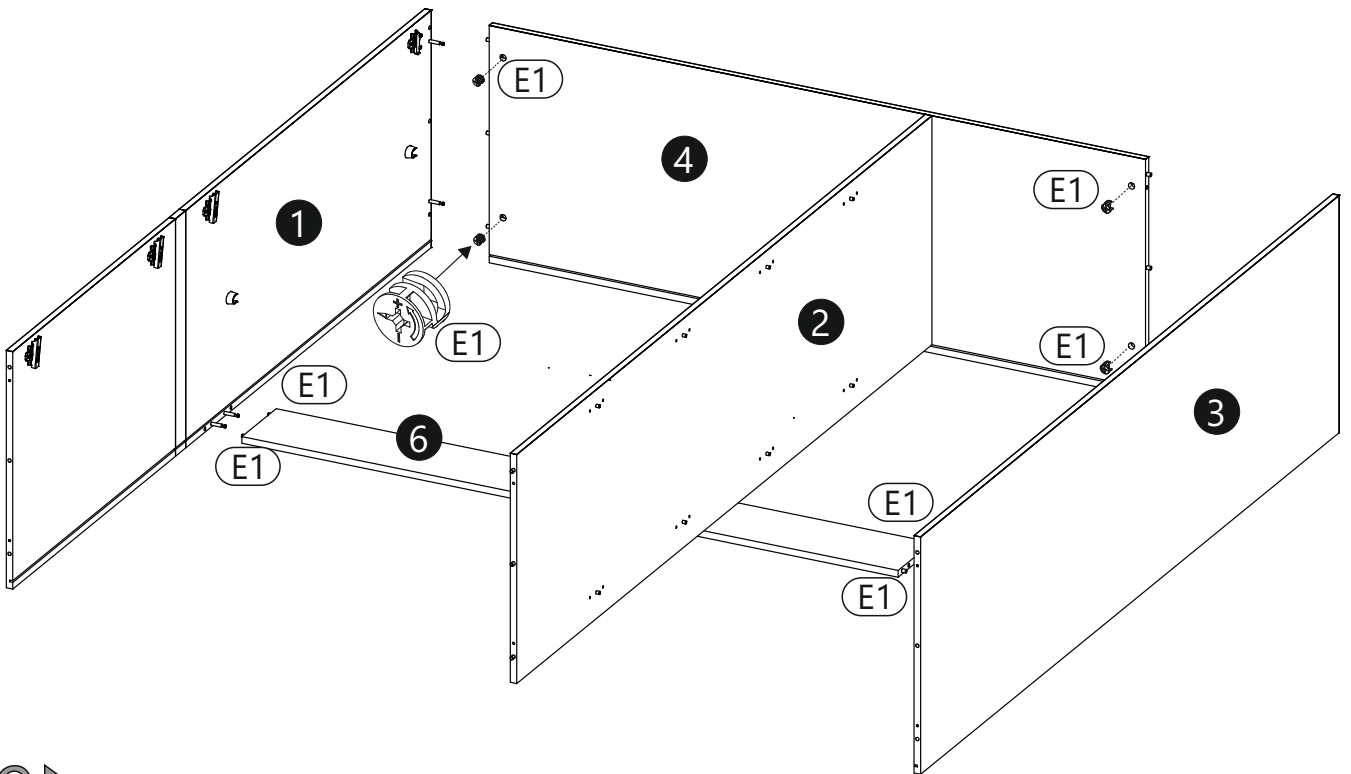

9 ▶

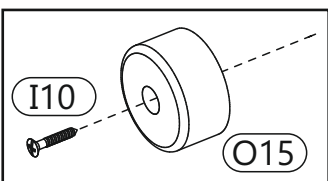
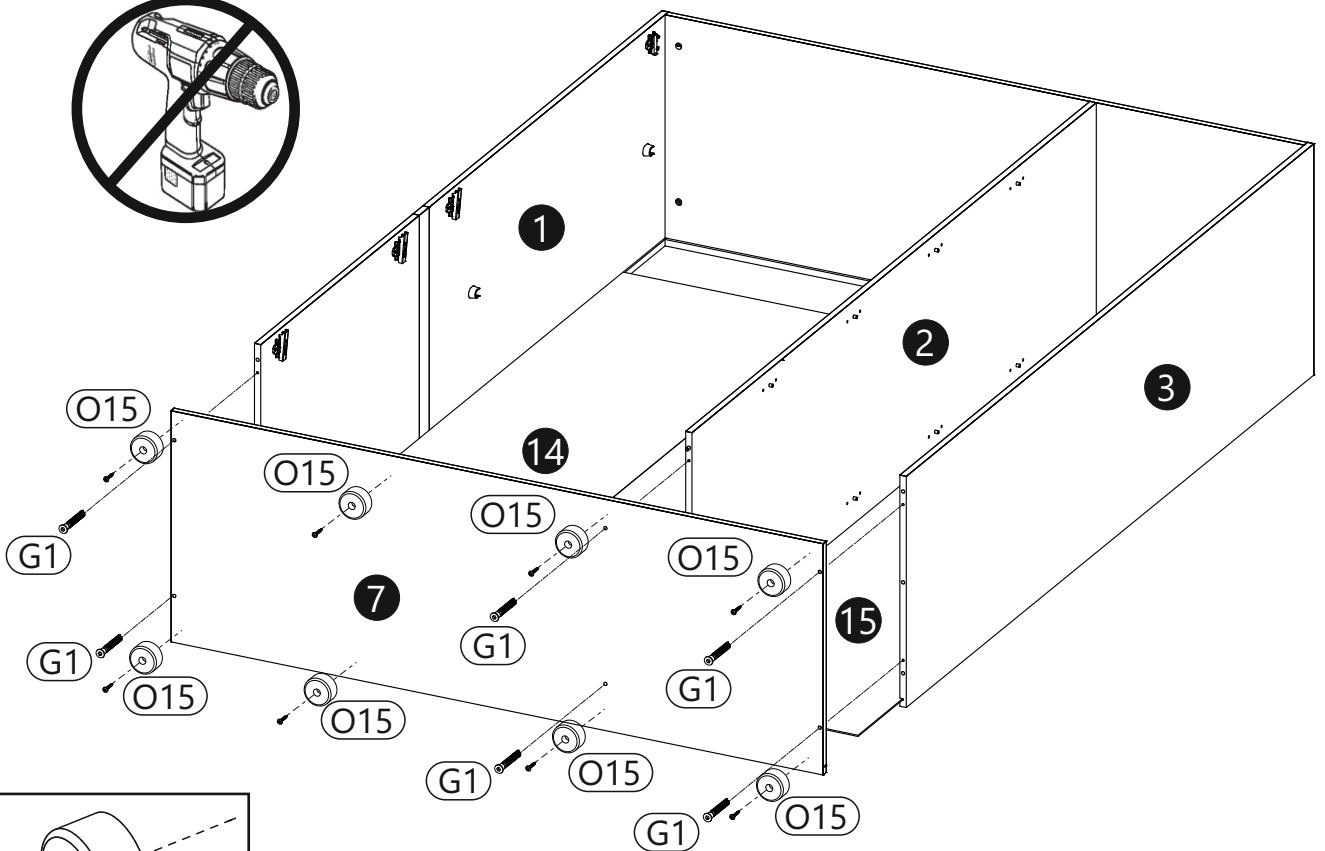
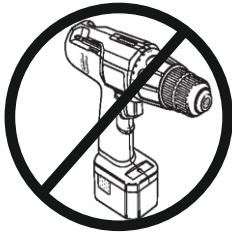

# 10 ▶

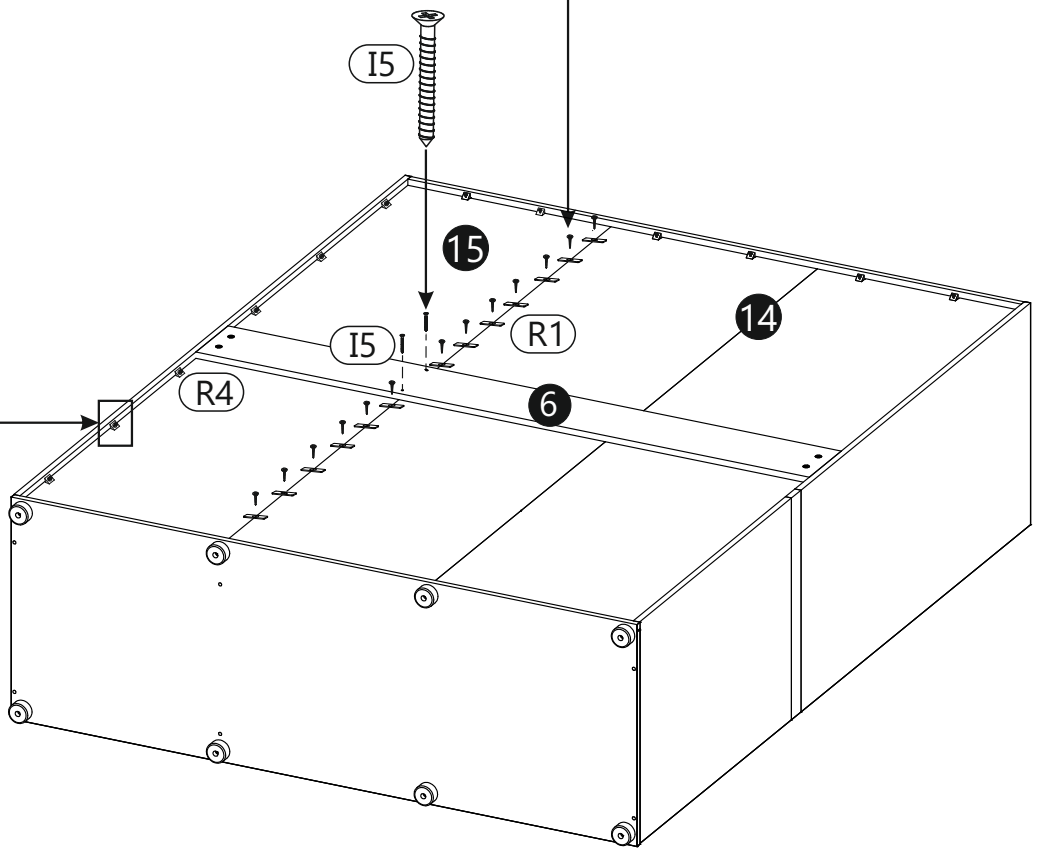
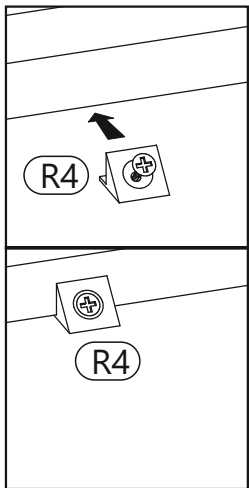
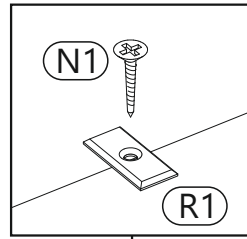
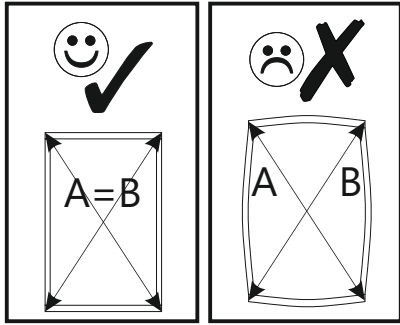

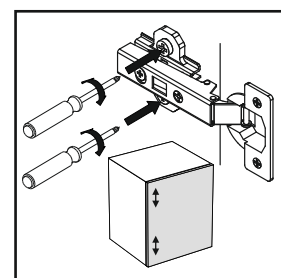
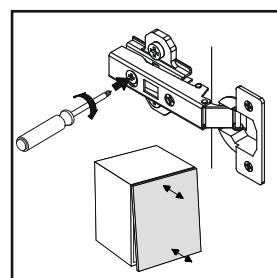
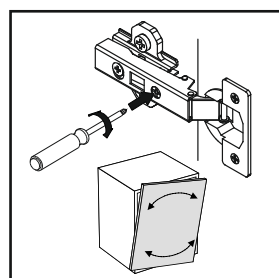
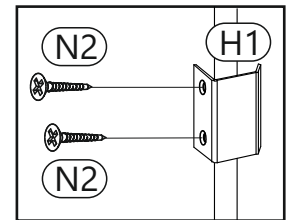
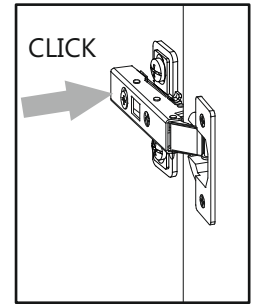
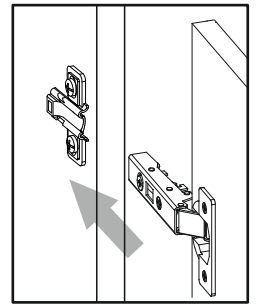
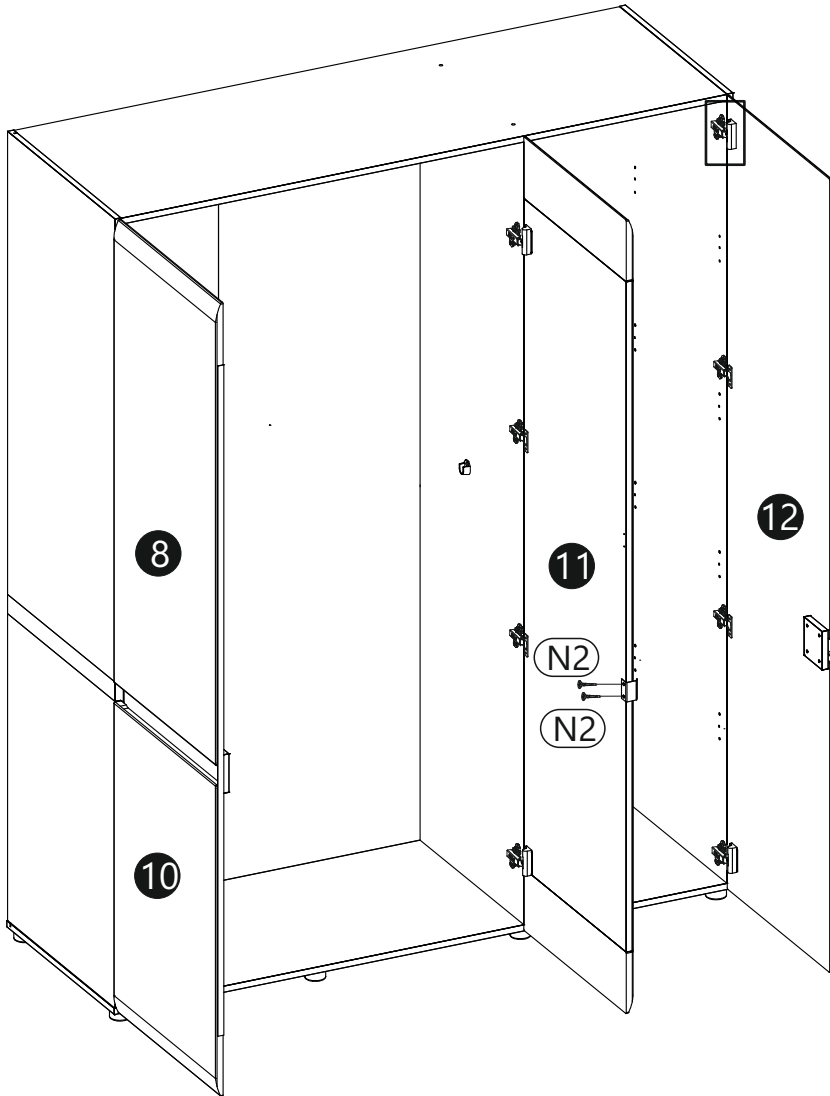

12 ▶

